

# Chapter 1

## Introduction to the Guide

The collection of extensive, reliable, oceanic carbon data was a key component of the Joint Global Ocean Flux Study (JGOFS) and World Ocean Circulation Experiment (WOCE) and continues to be a cornerstone of the global climate research effort. This Guide was originally prepared at the request, and with the active participation, of a science team formed by the U.S. Department of Energy (DOE) to carry out the first global survey of carbon dioxide in the oceans (DOE, 1994. Handbook of methods for the analysis of the various parameters of the carbon dioxide system in sea water; version 2, A.G. Dickson and C. Goyet, Eds. ORNL/CDIAC-74). The manual has been updated several times since, and the current version contains the most up-to-date information available on the chemistry of CO<sub>2</sub> in sea water and the methodology of determining carbon system parameters. This revision has been made possible by the generous support of the North Pacific Marine Science Organization (PICES), the International Ocean Carbon Coordination Project (IOCCP) co-sponsored by the Scientific Committee on Ocean Research (SCOR) and the Intergovernmental Oceanographic Commission (IOC) of UNESCO, and the Carbon Dioxide Information Analysis Center (CDIAC). The editors are extremely grateful to Alex Kozyr and Mikhail Krassovski at CDIAC for their hard work in helping us to complete this revised volume. This manual should be cited as Dickson, A.G., Sabine, C.L. and Christian, J.R. (Eds.) 2007. Guide to best practices for ocean CO<sub>2</sub> measurements. PICES Special Publication 3, 191 pp.

The procedures detailed in the following pages have been subjected to open review by the ocean carbon science community and describe well-tested methods. They are intended to provide standard operating procedures (SOPs), together with an appropriate quality control plan. These are not the only measurement techniques in use for the parameters of the oceanic carbon system; however, they do represent the current state-of-the-art for shipboard measurements. In the end, we hope that this manual can serve as a clear and unambiguous guide to other investigators who are setting up to analyze the various parameters of the carbon dioxide system in sea water. We envision it as an evolving document, updated where necessary. The editors welcome comments and suggestions for use in preparing future revisions. The procedures included

here are not simply descriptions of a particular method in current use in a single laboratory, but rather provide standard operating procedures which have been written in a fashion that will—we trust—allow anyone to implement the method successfully. In some cases there is no consensus about the best approach; these areas are identified in the footnotes to the various procedures along with other hints and tips.

In addition to the written procedures, general information about the solution chemistry of the carbon dioxide system in sea water has been provided (Chapter 2) together with recommended values for the physical and thermodynamic data needed for certain computations (Chapter 5). This information is needed to understand certain aspects of the procedures, and users of this Guide are advised to study Chapter 2 carefully. The user is cautioned that equilibrium constants employed in ocean carbon chemistry have specific values for different pH scales, and values in the published literature may be on different scales than the one used here; it is very important to make sure that all constants used in a particular calculation are on the same scale. General advice about appropriate quality control measures has also been included (Chapter 3). The SOPs (Chapter 4) are numbered. Numbers less than 10 are reserved for procedures describing sampling and analysis, numbers 11–20 for procedures for calibration, *etc.*, and numbers 21 and upward for procedures for computations and quality control. This scheme allows for the addition of further SOPs in the future. Each of the procedures has been marked with a date of last revision and a version number. When citing a particular SOP in a report or technical paper, we recommend stating the version number of the procedure used. We envision this Guide being further expanded and updated in the future; thus the version number identifies unambiguously the exact procedure that is being referred to. Any errors in the text or corrections that arise as the methods evolve can be reported to Alex Kozyr at CDIAC ([kozyra@ornl.gov](mailto:kozyra@ornl.gov)).

Andrew G. Dickson, Christopher L. Sabine, and James R. Christian  
Editors

# Chapter 2

## Solution chemistry of carbon dioxide in sea water

### 1. Introduction

This chapter outlines the chemistry of carbon dioxide in sea water so as to provide a coherent background for the rest of this Guide. The following sections lay out the thermodynamic framework required for an understanding of the solution chemistry; the thermodynamic data needed to interpret field and laboratory results are presented in Chapter 5.

### 2. Reactions in solution

The reactions that take place when carbon dioxide dissolves in water can be represented by the following series of equilibria:

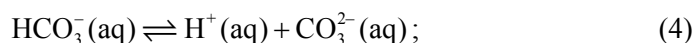
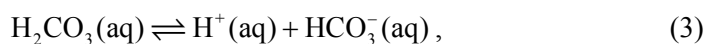
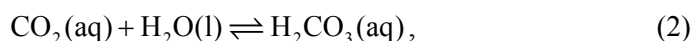

the notations (g), (l), (aq) refer to the state of the species, *i.e.*, a gas, a liquid or in aqueous solution respectively. It is difficult to analytically distinguish between the species  $\text{CO}_2(\text{aq})$  and  $\text{H}_2\text{CO}_3(\text{aq})$ . It is usual to combine the concentrations of  $\text{CO}_2(\text{aq})$  and  $\text{H}_2\text{CO}_3(\text{aq})$  and to express this sum as the concentration of a hypothetical species,  $\text{CO}_2^*(\text{aq})$ .

Redefining (1), (2), and (3) in terms of this species gives

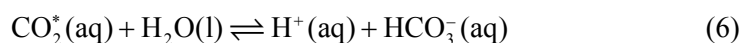

The equilibrium relationships between the concentrations of these various species can then be written as

$$K_0 = [\text{CO}_2^*] / f(\text{CO}_2), \quad (7)$$

$$K_1 = [\text{H}^+][\text{HCO}_3^-] / [\text{CO}_2^*], \quad (8)$$

$$K_2 = [\text{H}^+][\text{CO}_3^{2-}] / [\text{HCO}_3^-]. \quad (9)$$

In these equations,  $f(\text{CO}_2)$  is the fugacity of carbon dioxide in the gas phase and brackets represent total stoichiometric concentrations<sup>1</sup> of the particular chemical species enclosed. These equilibrium constants are functions of the temperature, pressure and salinity of the solution (*e.g.*, sea water) and have been measured in a variety of studies (see Chapter 5).

### 3. Fugacity

The fugacity of carbon dioxide is not the same as its partial pressure—the product of mole fraction and total pressure,  $x(\text{CO}_2) \cdot p$ —but rather takes account of the non-ideal nature of the gas phase. The fugacity of a gas such as  $\text{CO}_2$  can be determined from knowledge of its equation of state:

$$f(\text{CO}_2) = x(\text{CO}_2) \cdot p \cdot \exp\left(\frac{1}{RT} \int_0^p (V(\text{CO}_2) - RT/p') dp'\right). \quad (10)$$

The equation of state of a real gas such as  $\text{CO}_2$ , either alone or in a mixture, can be represented by a virial expression:

$$\frac{pV(\text{CO}_2)}{RT} = 1 + \frac{B(x, T)}{V(\text{CO}_2)} + \frac{C(x, T)}{V(\text{CO}_2)^2} + \dots \quad (11)$$

This equation, truncated after the second term, is usually adequate to represent  $p$ - $V$ - $T$  properties at pressures up to a few atmospheres (Dymond and Smith, 1980).

It is known from statistical mechanics that the virial coefficients  $B(x, T)$ ,  $C(x, T)$ , *etc.* relate to pair-wise interactions in the gas phase (Guggenheim, 1967). This property can be used to estimate  $B(x, T)$  for particular gas mixtures, such as  $\text{CO}_2$  in air, from measurements on binary mixtures or from a model of the intermolecular potential energy function for the molecules concerned. The magnitude of the fugacity coefficient (the ratio of fugacity to partial pressure) is a function both of temperature and of gas phase composition (Fig. 1).

<sup>1</sup> Strictly, equations (7) to (9) should be expressed in terms of activities rather than concentrations. However, as the activity coefficients are approximately constant for small amounts of reacting species in a background medium, these expressions are valid and correspond to “ionic medium” equilibrium constants based on a sea water medium.

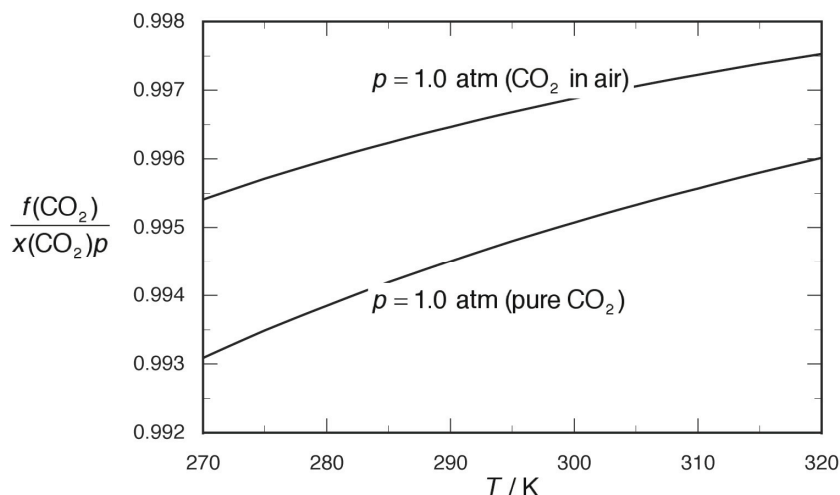

**Fig. 1** Variation of the fugacity coefficient with temperature at 1 atm total pressure for pure CO<sub>2</sub> gas and for CO<sub>2</sub> in air:  $x(\text{CO}_2) = 350 \times 10^{-6}$  (calculated using the procedure described in SOP 24 of this Guide).

## 4. Analytical parameters of the CO<sub>2</sub> system

Unfortunately, the concentrations of the individual species of the carbon dioxide system in solution can not be measured directly. There are, however, four parameters that can be measured. These are used together with ancillary information to obtain a complete description of the carbon dioxide system in sea water. Methods for determining each of these parameters are detailed in Chapter 4.

### 4.1 Total dissolved inorganic carbon

The total dissolved inorganic carbon in a sea water sample:

$$C_T = [\text{CO}_2^*] + [\text{HCO}_3^-] + [\text{CO}_3^{2-}] \quad (12)$$

can be measured directly by acidifying the sample, extracting the CO<sub>2</sub> gas that is produced and measuring its amount.

### 4.2 Total alkalinity

The total alkalinity of a sample of sea water is a form of mass-conservation relationship for hydrogen ion. It is rigorously defined (Dickson, 1981) as “. . . the number of moles of hydrogen ion equivalent to the excess of proton acceptors (bases formed from weak acids with a dissociation constant  $K \leq 10^{-4.5}$  at 25°C and zero ionic strength) over proton donors (acids with  $K > 10^{-4.5}$ ) in 1 kilogram of sample.” Thus

$$\begin{aligned} A_T = & [\text{HCO}_3^-] + 2[\text{CO}_3^{2-}] + [\text{B}(\text{OH})_4^-] + [\text{OH}^-] + [\text{HPO}_4^{2-}] \\ & + 2[\text{PO}_4^{3-}] + [\text{SiO}(\text{OH})_3^-] + [\text{NH}_3] + [\text{HS}^-] + \dots \\ & - [\text{H}^+]_F - [\text{HSO}_4^-] - [\text{HF}] - [\text{H}_3\text{PO}_4] - \dots \end{aligned} \quad (13)$$

where the ellipses stand for additional minor acid or base species that are either unidentified or present in such small amounts that they can be safely neglected.  $[\text{H}^+]_{\text{F}}$  is the *free* concentration of hydrogen ion—see equation (15).

### 4.3 Fugacity of $\text{CO}_2$ in equilibrium with a sea water sample

This measurement typically requires a gas phase that is in equilibrium with a sea water sample at a known pressure and temperature. The concentration of  $\text{CO}_2$  is then determined in the gas phase and the corresponding value of  $f(\text{CO}_2)$ —for that temperature—estimated from equation (10).

### 4.4 Total hydrogen ion concentration

The hydrogen ion concentration in sea water is usually reported as pH:

$$\text{pH} = -\log[\text{H}^+]. \quad (14)$$

Although the concept of a total hydrogen ion concentration is somewhat confusing<sup>2</sup>, it is needed to define acid dissociation constants accurately in sea water (Dickson, 1990). Total hydrogen ion concentration is defined as

$$[\text{H}^+] = [\text{H}^+]_{\text{F}} \cdot (1 + S_{\text{T}} / K_{\text{S}}). \quad (15)$$

$[\text{H}^+]_{\text{F}}$  is the *free* hydrogen ion concentration,  $S_{\text{T}}$  is the total sulfate concentration ( $[\text{SO}_4^{2-}] + [\text{HSO}_4^-]$ ) and  $K_{\text{S}}$  is the acid dissociation constant for  $\text{HSO}_4^-$ . At pH values above 4, equation (15) can be approximated as

$$[\text{H}^+] = [\text{H}^+]_{\text{F}} + [\text{HSO}_4^-]. \quad (16)$$

The various equilibrium constants required to describe acid–base chemistry in sea water have been measured in the laboratory (see Chapter 5 for recommended constants). In addition to knowing the carbon parameters, the total concentrations of the various other (non- $\text{CO}_2$ ) acid–base systems in the sample of interest are needed to fully constrain the carbon dioxide system in sea water. The total concentrations of conservative constituents, such as borate, sulfate, and fluoride, can be estimated from salinity. Those of non-conservative constituents, such as phosphate, silicate, ammonia or hydrogen sulfide, must be measured but approximate “reference” concentrations are adequate for most purposes. Because of the relative consistency of the chemical constituents of sea water, it is generally accepted that only two of the four measurable carbon parameters are needed together with the equilibrium constants, temperature, pressure, and salinity, to have a complete description of the system (see Park (1969), Skirrow (1975), and the Annexe to this chapter).

This practice assumes that our present knowledge of the nature, total concentrations, and thermodynamic properties of all the possible acid–base species in sea water is complete. It is probably better at this stage to over-determine the system whenever possible, *i.e.*, to measure more than two of these parameters on any given sample and to use the redundancy to confirm that the measurements fit with our understanding of the thermodynamics of acid–base processes in sea water.

<sup>2</sup> See Dickson (1984, 1993) for a detailed discussion of the various pH scales that have been used in sea water.

## 5. Bibliography

- Dickson, A.G. 1981. An exact definition of total alkalinity and a procedure for the estimation of alkalinity and total inorganic carbon from titration data. *Deep-Sea Res.* **28A**: 609–623.
- Dickson, A.G. 1984. pH scales and proton-transfer reactions in saline media such as sea water. *Geochim. Cosmochim. Acta* **48**: 2299–2308.
- Dickson, A.G. 1990. Standard potential of the reaction:  $\text{AgCl(s)} + \frac{1}{2}\text{H}_2(\text{g}) = \text{Ag(s)} + \text{HCl(aq)}$ , and the standard acidity constant of the ion  $\text{HSO}_4^-$  in synthetic sea water from 273.15 to 318.15 K. *J. Chem. Thermodyn.* **22**: 113–127.
- Dickson, A.G. 1993. The measurement of sea water pH. *Mar. Chem.* **44**: 131–142.
- Dymond, J.H. and Smith, E.B. 1980. The Virial Coefficients of Pure Gases and Mixtures: A Critical Compilation. Clarendon Press, 518 pp.
- Guggenheim, E.A. 1967. Thermodynamics. An Advanced Treatment for Chemists and Physicists, 5th edition, North-Holland, 390 pp.
- Park, K. 1969. Oceanic  $\text{CO}_2$  system: an evaluation of ten methods of investigation. *Limnol. Oceanogr.* **14**: 179–186.
- Skirrow, G. 1975. The dissolved gases—carbon dioxide. *In*: Chemical Oceanography, Vol. 2. Edited by J.P. Riley and G. Skirrow, Academic Press, London, pp. 1–192.

## Annexe

### Equations that describe the CO<sub>2</sub> system in sea water

It is possible, in theory, to obtain a *complete* description of the carbon dioxide system in a sample of sea water at a particular temperature and pressure provided that the following information is known<sup>3</sup>:

- the solubility constant for CO<sub>2</sub> in sea water,  $K_0$ ,
- the equilibrium constants for each of the acid–base pairs that are assumed to exist in the solution,
- the total concentrations of all the non-CO<sub>2</sub> acid–base pairs,
- the values of at least two of the CO<sub>2</sub> related parameters:  $C_T, A_T, f(\text{CO}_2), [\text{H}^+]$ .

The optimal choice of experimental variables is dictated by the nature of the problem being studied and remains at the discretion of the investigator. Although each of the CO<sub>2</sub> related parameters is linearly independent, they are not orthogonal. For certain combinations there are limits to the accuracy with which the other parameters can be predicted from the measured data. These errors end up being propagated through the equations presented here. Such errors result from all the experimentally derived information, including the various equilibrium constants. As a consequence it is usually better to *measure* a particular parameter directly using one of the methods detailed in Chapter 4 than to calculate it from other measurements.

When more than two of the CO<sub>2</sub>-related parameters have been measured on a single sea water sample, it is possible to use the various possible pairs of parameters to compute the other redundant parameters and thus to assess the internal consistency of our knowledge of the system. Again, it is necessary to take all the sources of error into account when doing this. Alternately, one can describe the system independently of one or more of the dissociation constants for carbonic acid. Equations that allow each of these possibilities to be realized are derived here.

---

<sup>3</sup> The rank of the system of equilibrium equations that describes the acid–base chemistry of sea water—*i.e.*, the number of linearly independent variables—is equal to the number of independent mass-conservation relationships plus the number of acid–base pairs considered (the number of dissociation constants).



**Table 1** Equations for the sea water acid–base system.**Mass-conservation equations<sup>4</sup>**

$$C_T = [\text{CO}_2^*] + [\text{HCO}_3^-] + [\text{CO}_3^{2-}] \quad (17)$$

$$\begin{aligned} A_T = & [\text{HCO}_3^-] + 2[\text{CO}_3^{2-}] + [\text{B}(\text{OH})_4] + [\text{OH}^-] + [\text{HPO}_4^{2-}] \\ & + 2[\text{PO}_4^{3-}] + [\text{SiO}(\text{OH})_3^-] + [\text{NH}_3] + [\text{HS}^-] + \dots \\ & - [\text{H}^+]_F - [\text{HSO}_4^-] - [\text{HF}] - [\text{H}_3\text{PO}_4] - \dots \end{aligned} \quad (18)$$

$$B_T = [\text{B}(\text{OH})_3] + [\text{B}(\text{OH})_4^-] \quad (19)$$

$$S_T = [\text{HSO}_4^-] + [\text{SO}_4^{2-}] \quad (20)$$

$$F_T = [\text{HF}] + [\text{F}^-] \quad (21)$$

$$P_T = [\text{H}_3\text{PO}_4] + [\text{H}_2\text{PO}_4^-] + [\text{HPO}_4^{2-}] + [\text{PO}_4^{3-}] \quad (22)$$

$$Si_T = [\text{Si}(\text{OH})_4] + [\text{SiO}(\text{OH})_3^-] \quad (23)$$

$$NH_{3T} = [\text{NH}_4^+] + [\text{NH}_3] \quad (24)$$

$$H_2S_T = [\text{H}_2\text{S}] + [\text{HS}^-] \quad (25)$$

**Equilibrium constants**

$$K_0 = [\text{CO}_2^*]/f(\text{CO}_2) \quad (26)$$

$$K_1 = [\text{H}^+][\text{HCO}_3^-]/[\text{CO}_2^*] \quad (27)$$

$$K_2 = [\text{H}^+][\text{CO}_3^{2-}]/[\text{HCO}_3^-] \quad (28)$$

$$K_B = [\text{H}^+][\text{B}(\text{OH})_4^-]/[\text{B}(\text{OH})_3] \quad (29)$$

$$K_w = [\text{H}^+][\text{OH}^-] \quad (30)$$

$$K_S = [\text{H}^+][\text{SO}_4^{2-}]/[\text{HSO}_4^-] \quad (31)$$

$$K_F = [\text{H}^+][\text{F}^-]/[\text{HF}] \quad (32)$$

$$K_{1P} = [\text{H}^+][\text{H}_2\text{PO}_4^-]/[\text{H}_3\text{PO}_4] \quad (33)$$

$$K_{2P} = [\text{H}^+][\text{HPO}_4^{2-}]/[\text{H}_2\text{PO}_4^-] \quad (34)$$

$$K_{3P} = [\text{H}^+][\text{PO}_4^{3-}]/[\text{HPO}_4^{2-}] \quad (35)$$

$$K_{Si} = [\text{H}^+][\text{SiO}(\text{OH})_3^-]/[\text{Si}(\text{OH})_4] \quad (36)$$

$$K_{\text{NH}_3} = [\text{H}^+][\text{NH}_3]/[\text{NH}_4^+] \quad (37)$$

$$K_{\text{H}_2\text{S}} = [\text{H}^+][\text{HS}^-]/[\text{H}_2\text{S}] \quad (38)$$

<sup>4</sup> The aqueous chemistry of Si is rather complex, and encompasses more species than are considered here. This approximation is adequate for the present purpose of estimating the silicate contribution to alkalinity.

**Table 2** Expressions for the concentrations of the various species in equation (18).

$$[\text{HCO}_3^-] = \frac{C_T K_1 [\text{H}^+]}{[\text{H}^+]^2 + K_1 [\text{H}^+] + K_1 K_2} \quad (39)$$

$$[\text{CO}_3^{2-}] = \frac{C_T K_1 K_2}{[\text{H}^+]^2 + K_1 [\text{H}^+] + K_1 K_2} \quad (40)$$

$$[\text{B}(\text{OH})_4^-] = B_T / (1 + [\text{H}^+] / K_B) \quad (41)$$

$$[\text{OH}^-] = K_w / [\text{H}^+] \quad (42)$$

$$[\text{H}_3\text{PO}_4] = \frac{P_T [\text{H}^+]^3}{[\text{H}^+]^3 + K_{1P} [\text{H}^+]^2 + K_{1P} K_{2P} [\text{H}^+] + K_{1P} K_{2P} K_{3P}} \quad (43)$$

$$[\text{H}_2\text{PO}_4^-] = \frac{P_T K_{1P} [\text{H}^+]^2}{[\text{H}^+]^3 + K_{1P} [\text{H}^+]^2 + K_{1P} K_{2P} [\text{H}^+] + K_{1P} K_{2P} K_{3P}} \quad (44)$$

$$[\text{HPO}_4^{2-}] = \frac{P_T K_{1P} K_{2P} [\text{H}^+]}{[\text{H}^+]^3 + K_{1P} [\text{H}^+]^2 + K_{1P} K_{2P} [\text{H}^+] + K_{1P} K_{2P} K_{3P}} \quad (45)$$

$$[\text{PO}_4^{3-}] = \frac{P_T K_{1P} K_{2P} K_{3P}}{[\text{H}^+]^3 + K_{1P} [\text{H}^+]^2 + K_{1P} K_{2P} [\text{H}^+] + K_{1P} K_{2P} K_{3P}} \quad (46)$$

$$[\text{SiO}(\text{OH})_3^-] = S_{iT} / (1 + [\text{H}^+] / K_{Si}) \quad (47)$$

$$[\text{NH}_3] = N H_{3T} / (1 + [\text{H}^+] / K_{\text{NH}_3}) \quad (48)$$

$$[\text{HS}^-] = H_2 S_T / (1 + [\text{H}^+] / K_{\text{H}_2\text{S}}) \quad (49)$$

$$[\text{H}^+]_F = [\text{H}^+] / (1 + S_T / K_S) \quad (50)$$

$$[\text{HSO}_4^-] = S_T / (1 + K_S / [\text{H}^+]_F) \quad (51)$$

$$[\text{HF}] = F_T / (1 + K_F / [\text{H}^+]) \quad (52)$$

## $[\text{H}^+]$ and $A_T$

The carbonate alkalinity (*i.e.*, the contribution of carbonate species to the total alkalinity) is defined as

$$A_C = [\text{HCO}_3^-] + 2[\text{CO}_3^{2-}] \quad (53)$$

The concentrations of the non-CO<sub>2</sub> species that contribute to  $A_T$  are calculated using the expressions given in Table 2, thus

$$\begin{aligned} A_C = A_T - & ([\text{B}(\text{OH})_4^-] + [\text{OH}^-] + [\text{HPO}_4^{2-}] + 2[\text{PO}_4^{3-}] \\ & + [\text{SiO}(\text{OH})_3^-] + [\text{NH}_3] + [\text{HS}^-] + \dots \\ & - [\text{H}^+]_F - [\text{HSO}_4^-] - [\text{HF}] - [\text{H}_3\text{PO}_4] - \dots) \end{aligned} \quad (54)$$

Then from (27),

$$[\text{HCO}_3^-] = \frac{[\text{CO}_2^*]K_1}{[\text{H}^+]}, \quad (55)$$

and from (28),

$$[\text{CO}_3^{2-}] = \left( \frac{[\text{CO}_2^*]K_1}{[\text{H}^+]} \right) \frac{K_2}{[\text{H}^+]}. \quad (56)$$

Substituting into (53) and rearranging,

$$[\text{CO}_2^*] = \frac{A_c[\text{H}^+]^2}{K_1([\text{H}^+] + 2K_2)}, \quad (57)$$

and hence

$$[\text{HCO}_3^-] = \frac{A_c[\text{H}^+]}{[\text{H}^+] + 2K_2}, \quad (58)$$

$$[\text{CO}_3^{2-}] = \frac{A_c K_2}{[\text{H}^+] + 2K_2}. \quad (59)$$

$C_T$  is calculated from (17) and  $f(\text{CO}_2)$  from (26):

$$f(\text{CO}_2) = \frac{[\text{CO}_2^*]}{K_0}. \quad (60)$$

### $[\text{H}^+]$ and $f(\text{CO}_2)$

$[\text{CO}_2^*]$  is given by (26):

$$[\text{CO}_2^*] = K_0 f(\text{CO}_2). \quad (61)$$

Thus, from (27) and (28),

$$[\text{HCO}_3^-] = \frac{K_0 K_1 f(\text{CO}_2)}{[\text{H}^+]}, \quad (62)$$

$$[\text{CO}_3^{2-}] = \frac{K_0 K_1 K_2 f(\text{CO}_2)}{[\text{H}^+]^2}. \quad (63)$$

$C_T$  is calculated from (17) and  $A_T$  from (18);  $[\text{HCO}_3^-]$  and  $[\text{CO}_3^{2-}]$  are given by (62) and (63), the remaining terms are calculated from the expressions given in Table 2.

### $[\text{H}^+]$ and $C_T$

Equations (27) and (28) are rearranged and substituted into (17) to give

$$C_T = [\text{CO}_2^*] \left( 1 + \frac{K_1}{[\text{H}^+]} + \frac{K_1 K_2}{[\text{H}^+]^2} \right). \quad (64)$$

Thus

$$[\text{CO}_2^*] = \frac{C_T [\text{H}^+]^2}{[\text{H}^+]^2 + K_1 [\text{H}^+] + K_1 K_2}, \quad (65)$$

$$[\text{HCO}_3^-] = \frac{C_T K_1 [\text{H}^+]}{[\text{H}^+]^2 + K_1 [\text{H}^+] + K_1 K_2}, \quad (66)$$

$$[\text{CO}_3^{2-}] = \frac{C_T K_1 K_2}{[\text{H}^+]^2 + K_1 [\text{H}^+] + K_1 K_2}. \quad (67)$$

$f(\text{CO}_2)$  is calculated from (60) and  $A_T$  from (18); the various terms needed are calculated from the expressions given in Table 2.

### $A_T$ and $C_T$

The easiest approach to using this pair of parameters is to rewrite (18), the expression for  $A_T$ , in terms of total concentrations and  $[\text{H}^+]$  (see Table 2). The resulting equation is solved for  $[\text{H}^+]$  using either a Newton–Raphson technique or a simple iterative approach; a suitable initial estimate for calculations involving sea water is:  $[\text{H}^+] = 10^{-8} \text{ mol kg}^{-1}$ .

Once  $[\text{H}^+]$  has been calculated,

$$[\text{HCO}_3^-] = \frac{C_T K_1 [\text{H}^+]}{[\text{H}^+]^2 + K_1 [\text{H}^+] + K_1 K_2}, \quad (68)$$

$$[\text{CO}_3^{2-}] = \frac{C_T K_1 K_2}{[\text{H}^+]^2 + K_1 [\text{H}^+] + K_1 K_2}. \quad (69)$$

$[\text{CO}_2^*]$  is then calculated from

$$[\text{CO}_2^*] = \frac{[\text{H}^+][\text{HCO}_3^-]}{K_1} \quad (70)$$

and  $f(\text{CO}_2)$  is calculated from (60).

### $A_T$ and $f(\text{CO}_2)$

$[\text{CO}_2^*]$  is given by (26):

$$[\text{CO}_2^*] = K_0 f(\text{CO}_2). \quad (71)$$

Equations (27) and (28) are then rewritten as

$$[\text{HCO}_3^-] = \frac{K_0 K_1 f(\text{CO}_2)}{[\text{H}^+]}, \quad (72)$$

$$[\text{CO}_3^{2-}] = \frac{K_0 K_1 K_2 f(\text{CO}_2)}{[\text{H}^+]^2}. \quad (73)$$

These terms are substituted into (18) together with the remaining terms from Table 2. The resulting expression is solved for  $[H^+]$  using either a Newton–Raphson technique or a simple iterative approach; a suitable initial estimate for ocean water is:  $[H^+] = 10^{-8} \text{ mol kg}^{-1}$ . Once  $[H^+]$  has been calculated,  $C_T$  is calculated from (17) using the final values obtained for  $[HCO_3^-]$  and  $[CO_3^{2-}]$ .

## $C_T$ and $f(CO_2)$

For this calculation, it is convenient to define the constant

$$K = K_1/K_2 = \frac{[HCO_3^-]^2}{[CO_2^*][CO_3^{2-}]} \quad (74)$$

For the equilibrium process,

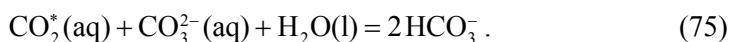

$[CO_2^*]$  is given by (26):

$$[CO_2^*] = K_0 f(CO_2) \quad (76)$$

and combining (17) and (74) gives

$$C_T = K_0 f(CO_2) + [HCO_3^-] + \frac{[HCO_3^-]^2}{KK_0 f(CO_2)} \quad (77)$$

Rearranging,

$$\begin{aligned} [HCO_3^-]^2 + KK_0 f(CO_2)[HCO_3^-] \\ + KK_0 f(CO_2)(K_0 f(CO_2) - C_T) = 0. \end{aligned} \quad (78)$$

The solution is

$$\begin{aligned} [HCO_3^-] = \frac{1}{2} \left[ -KK_0 f(CO_2) + \left( (KK_0 f(CO_2))^2 \right. \right. \\ \left. \left. - 4(KK_0 f(CO_2))(K_0 f(CO_2) - C_T) \right)^{1/2} \right] \end{aligned} \quad (79)$$

and

$$[CO_3^{2-}] = C_T - [CO_2^*] - [HCO_3^-] \quad (80)$$

$[H^+]$  is calculated from (27):

$$[H^+] = \frac{K_1[CO_2^*]}{[HCO_3^-]} \quad (81)$$

$A_T$  from (18): the various terms needed are calculated from the expressions given in Table 2.

### $[\text{H}^+]$ , $A_T$ and $C_T$

The concentrations of the non- $\text{CO}_2$  species that contribute to  $A_T$  are calculated using the expressions given in Table 2. The carbonate alkalinity,  $A_C$ , is then calculated from (54). Equations (17), (27), and (53) can then be combined to give

$$2C_T - A_C = [\text{CO}_2^*] \left( 2 + \frac{K_1}{[\text{H}^+]} \right). \quad (82)$$

Hence

$$[\text{CO}_2^*] = \frac{[\text{H}^+](2C_T - A_C)}{2[\text{H}^+] + K_1}, \quad (83)$$

$$[\text{HCO}_3^-] = \frac{K_1(2C_T - A_C)}{2[\text{H}^+] + K_1}, \quad (84)$$

$$\begin{aligned} [\text{CO}_3^{2-}] &= A_C - C_T + [\text{CO}_2^*] \\ &= \frac{[\text{H}^+]A_C + K_1(A_C - C_T)}{2[\text{H}^+] + K_1}. \end{aligned} \quad (85)$$

An expression for  $[\text{CO}_2^*]$  can also be derived in terms of  $K_2$ :

$$[\text{CO}_2^*] = C_T - [\text{HCO}_3^-] - [\text{CO}_3^{2-}] \quad (86)$$

and  $[\text{HCO}_3^-]$  and  $[\text{CO}_3^{2-}]$  are given by (58) and (59), thus

$$[\text{CO}_2^*] = C_T - \frac{A_C([\text{H}^+] + K_2)}{[\text{H}^+] + 2K_2}. \quad (87)$$

$f(\text{CO}_2)$  is then calculated from (60).

### $[\text{H}^+]$ , $A_T$ and $f(\text{CO}_2)$

The concentrations of the contributions of the various non- $\text{CO}_2$  species to  $A_T$  are calculated using the expressions given in Table 2.  $A_C$  is calculated from (54). Then, from (26),

$$[\text{CO}_2^*] = K_0 f(\text{CO}_2) \quad (88)$$

and from (27),

$$[\text{HCO}_3^-] = \frac{K_0 K_1 f(\text{CO}_2)}{[\text{H}^+]}, \quad (89)$$

Then, from (28) and (53),

$$[\text{CO}_3^{2-}] = \frac{A_C[\text{H}^+] - K_0 K_1 f(\text{CO}_2)}{2[\text{H}^+]}. \quad (90)$$

There are no equations that can be used to calculate these independently of  $K_1$ .  $C_T$  is calculated from (17).

**[H<sup>+</sup>], C<sub>T</sub> and f(CO<sub>2</sub>)**

From (26),

$$[\text{CO}_2^*] = K_0 f(\text{CO}_2). \quad (91)$$

[HCO<sub>3</sub><sup>-</sup>] is given either by

$$[\text{HCO}_3^-] = \frac{K_0 K_1 f(\text{CO}_2)}{[\text{H}^+]}, \quad (92)$$

or can be obtained from (17) and (28):

$$\begin{aligned} [\text{HCO}_3^-] &= C_T - [\text{CO}_2^*] - \frac{[\text{HCO}_3^-] K_2}{[\text{H}^+]} \\ &= \frac{[\text{H}^+](C_T - K_0 f(\text{CO}_2))}{[\text{H}^+] + K_2}. \end{aligned} \quad (93)$$

[CO<sub>3</sub><sup>2-</sup>] can be obtained either from [H<sup>+</sup>] and f(CO<sub>2</sub>):

$$\begin{aligned} [\text{CO}_3^{2-}] &= C_T - [\text{CO}_2^*] - [\text{HCO}_3^-] \\ &= C_T - K_0 f(\text{CO}_2) (1 + K_1/[\text{H}^+]) \end{aligned} \quad (94)$$

or from the equation for [HCO<sub>3</sub><sup>-</sup>] above, (93):

$$[\text{CO}_3^{2-}] = \frac{(C_T - K_0 f(\text{CO}_2)) K_2}{[\text{H}^+] + K_2}. \quad (95)$$

A<sub>T</sub> is then calculated from (18), the terms for [HCO<sub>3</sub><sup>-</sup>] and [CO<sub>3</sub><sup>2-</sup>] are given by either (92) and (94), in terms of K<sub>1</sub>, or (93) and (95), in terms of K<sub>2</sub>. The remaining terms are calculated from the expressions given in Table 2.

**[H<sup>+</sup>], A<sub>T</sub>, C<sub>T</sub> and f(CO<sub>2</sub>)**

The following sets of equations have the property that they do not embody directly either of the dissociation constants functions K<sub>1</sub> or K<sub>2</sub>. The carbonate alkalinity, A<sub>C</sub>, is first calculated from A<sub>T</sub> and [H<sup>+</sup>] using (54) and the expressions in Table 2.

[CO<sub>2</sub><sup>\*</sup>] is calculated from (26):

$$[\text{CO}_2^*] = K_0 f(\text{CO}_2) \quad (96)$$

and then

$$[\text{HCO}_3^-] = 2C_T - A_C - 2K_0 f(\text{CO}_2), \quad (97)$$

$$[\text{CO}_3^{2-}] = A_C - C_T + K_0 f(\text{CO}_2). \quad (98)$$

The dissociation constants for carbonic acid can then be calculated from (27) and (28).

# Chapter 3

## Quality assurance

### 1. Introduction

This chapter is intended to indicate some general principles of analytical quality assurance appropriate to the measurement of oceanic CO<sub>2</sub> parameters. Specific applications of analytical quality control are detailed as part of the individual standard operating procedures (Chapter 4).

Quality assurance constitutes the system by which an analytical laboratory can assure outside users that the analytical results they produce are of proven and known quality (Dux, 1990). In the past, the quality of most oceanic carbon data has depended on the skill and dedication of individual analysts. A formal quality assurance program is required for the development of a global ocean carbon data set, which depends on the consistency between measurements made by a variety of laboratories over an extended period of time<sup>1</sup>. Such a program was initiated during the World Ocean Circulation Experiment (WOCE) and Joint Global Ocean Flux Study (JGOFS) as described in the first (1994) edition of this manual. A quality assurance program consists of two separate related activities, quality control and quality assessment (Taylor, 1987):

*Quality control* — The overall system of activities whose purpose is to control the quality of a measurement so that it meets the needs of users. The aim is to ensure that data generated are of known accuracy to some stated, quantitative degree of probability, and thus provides quality that is satisfactory, dependable, and economic.

*Quality assessment* — The overall system of activities whose purpose is to provide assurance that quality control is being done effectively. It provides a continuing evaluation of the quality of the analyses and of the performance of the analytical system.

---

<sup>1</sup> An outline of how to go about establishing a formal quality assurance program for an analytical laboratory has been described by Dux (1990), additional useful information can be found in the book by Taylor (1987).



## 2. Quality control

The aim of quality control is to provide a stable measurement system whose properties can be treated statistically, *i.e.*, the measurement is “in control”. Anything that can influence the measurement process must be optimized and stabilized to the extent necessary and possible if reproducible measurements are to be obtained. Measurement quality can be influenced by a variety of factors that are classified into three main categories (Taylor and Oppermann, 1986): management practices, personnel training and technical operations.

Although emphasis on quality by laboratory management, together with competence and training of individual analysts, is essential to the production of data of high quality (see Taylor and Oppermann, 1986; Taylor, 1987; Vijverberg and Cofino, 1987; Dux, 1990), these aspects are not discussed further here. The emphasis in this Guide is on documenting various standard procedures so that all technical operations are carried out in a reliable and consistent manner.

The first requirement of quality control is for the use of suitable and properly maintained equipment and facilities. These are complemented by the use of documented Good Laboratory Practices (GLPs), Good Measurement Practices (GMPs) and Standard Operating Procedures (SOPs).

GLPs refer to general practices that relate to many of the measurements in a laboratory such as maintenance of equipment and facilities, records, sample management and handling, reagent control and storage, and cleaning of laboratory glassware. GMPs are essentially technique specific. Both GLPs and GMPs should be developed and documented by each laboratory so as to identify critical operations that can cause variance or bias.

SOPs describe the way specific operations or analytical methods should be carried out. They comprise written instructions which define completely the procedure to be adopted by an analyst to obtain the required result. Well written SOPs include tolerances for all critical parameters that must be observed to obtain results of a specified accuracy. This Guide contains a number of such SOPs, many of which have been in use since the early 1990s, and have been revised with accumulated experience and improved technology.

## 3. Quality assessment

A key part of any quality assurance program is the statistical evaluation of the quality of the data output (see SOPs 22 and 23). There are both internal and external techniques for quality assessment (Table 1). Most of these are self evident; some are discussed in more detail below.

**Table 1** Quality assessment techniques (after Taylor, 1987).

---

<b>Internal techniques</b>
Repetitive measurements
Internal test samples
Control charts
Interchange of operators
Interchange of equipment
Independent measurements
Measurements using a definitive method
Audits
<b>External techniques</b>
Collaborative tests
Exchange of samples
External reference materials
Certified reference materials
Audits

---

### 3.1 Internal techniques

Duplicate measurements of an appropriate number of samples provide an evaluation of precision that is needed while minimizing the level of pre-cruise preparation involved and eliminates all question of the appropriateness of the samples. At least 12 pairs distributed across the time and space scales of each measurement campaign (*i.e.*, each leg of a cruise) are needed to estimate a standard deviation with reasonable confidence. Ideally, if resources allow, one would like to collect and analyze duplicate samples from approximately 10% of the sample locations (*e.g.*, 3 sets of duplicates from a 36 position rosette). In cases where multiple instruments are used to increase sample throughput, replicate samples analyzed on each instrument provide useful cross-calibration documentation.

An internal test solution of reasonable stability can also be used to monitor precision (and bias, if the test solution value is known with sufficient accuracy). For example, the analysis of sub-samples from a large container of deep ocean water is frequently used to monitor the reproducibility of total alkalinity measurements. Historical data on a laboratory's own test solution can be used to develop a control chart and thus monitor and assess measurement precision<sup>2</sup>.

---

<sup>2</sup> Considerable confusion exists between the terms *precision* and *accuracy*. Precision is a measure of how *reproducible* a particular experimental procedure is. It can refer either to a particular stage of the procedure, *e.g.*, the final analysis, or to the entire procedure including sampling and sample handling. It is estimated by performing replicate measurements and estimating a mean and standard deviation from the results obtained. Accuracy, however, is a measure of the degree of agreement of a measured value with the "true" value. An accurate method provides unbiased results. It is a much more difficult quantity to estimate and can only be inferred by careful attention to possible sources of systematic error.

A laboratory should also conduct regular audits to ensure that its quality assurance program is indeed being carried out appropriately and that the necessary documentation is being maintained.

### 3.2 External techniques

External evidence for the quality of the measurement process is important for several reasons. First, it provides the most straightforward approach for assuring the compatibility of the measurements with other laboratories. Second, errors can arise over time that internal evaluations can not detect. External quality assessment techniques, however, should supplement, but not replace, a laboratory's ongoing internal quality assessment program.

Collaborative test exercises provide the opportunity to compare an individual laboratory's performance with that of others. If the results for the test samples are known accurately, biases can be evaluated. Such exercises were organized as part of the WOCE/JGOFS CO<sub>2</sub> survey and provided a useful tool for estimating overall data quality (Dickson, 2001; Feely *et al.*, 2001). Exchange of samples, or of internal test solutions with other laboratories can provide similar evidence of the level of agreement or possible biases in particular laboratories.

The use of reference materials to evaluate measurement capability is the procedure of choice whenever suitable reference materials are available. Reference materials are stable substances for which one or more properties are established sufficiently well to calibrate a chemical analyzer, or to validate a measurement process (Taylor, 1987). Ideally, such materials are based on a matrix similar to that of the samples of interest, in this case, sea water. The most useful reference materials are those for which one or more properties have been *certified* as accurate, preferably by the use of a definitive method in the hands of two or more analysts. Reference materials test the full measurement process (though not the sampling).

The U.S. National Science Foundation funded the development of certified reference materials (CRMs) for the measurement of oceanic CO<sub>2</sub> parameters (Dickson, 2001); the U.S. Department of Energy promoted the widespread use of CRMs by providing to participants (both from the U.S. and from other nations) in the WOCE/JGOFS CO<sub>2</sub> survey, the time-series stations at Hawaii and Bermuda and to other JGOFS investigations (Feely *et al.*, 2001). The Scripps Institution of Oceanography CRMs have proven to be a valuable quality assessment tool over the last decade and are currently widely used by the international ocean carbon community<sup>3</sup>. We recommend their use in the individual SOPs (see Table 2 for their certification status). Ideally, CRMs should be analyzed on each instrument any time a component of the system is changed (*e.g.*, with each new coulometer cell for  $C_T$ ) or at least once per day. If resources are limited, a minimum of 12 CRMs, spread evenly over the timeframe of the expedition, should be analyzed to give reasonable confidence in the average value.

---

<sup>3</sup> Available from Dr. Andrew G. Dickson, Marine Physical Laboratory, Scripps Institution of Oceanography, University of California, San Diego, 9500 Gilman Drive, La Jolla, CA 92093-0244, U.S.A. (fax: 1-858-822-2919; e-mail: [co2crms@ucsd.edu](mailto:co2crms@ucsd.edu); <http://andrew.ucsd.edu/co2qc/>).

**Table 2** Present status (2007) of certified reference materials for the quality control of oceanic carbon dioxide measurements.

Analytical Measurement	Desired Accuracy <sup>a</sup>	Certification
total dissolved inorganic carbon	$\pm 1 \mu\text{mol kg}^{-1}$	since 1991
total alkalinity	$\pm 1 \mu\text{mol kg}^{-1}$	since 1996 <sup>b</sup>
pH	$\pm 0.002$	— <sup>c</sup>
$f(\text{CO}_2)$	$\pm 0.05 \text{ Pa (} 0.5 \mu\text{atm)}$	— <sup>d</sup>

<sup>a</sup> Based on considerations outlined in the report of SCOR Working Group 75 (SCOR, 1985). They reflect the desire to measure changes in the  $\text{CO}_2$  content of sea water that allow the increases due to the burning of fossil fuels to be observed.

<sup>b</sup> Representative samples of earlier batches were also certified for alkalinity at that time.

<sup>c</sup> The pH of a reference material can be calculated from the measurements of total dissolved inorganic carbon and total alkalinity. Also, buffer solutions based on TRIS in synthetic sea water can be certified for pH, but—as yet—this is not done regularly.

<sup>d</sup>  $\text{CO}_2$  in air reference materials are presently available through a variety of sources. However, it is desirable to use a sterilized sea water sample as a reference material for a discrete  $f(\text{CO}_2)$  measurement. Although the thermodynamics of the sea water system suggest that, since the CRMs are certified stable for  $C_T$ ,  $A_T$ , and pH, they should be stable for  $f(\text{CO}_2)$ , a reliable technique for independently determining  $f(\text{CO}_2)$  to allow proper certification has not yet been developed.

#### 4. Calibration of temperature measurements

The accurate measurement of temperature is central to many of the SOPs included in this Guide, yet, on a number of occasions, it has been apparent that the calibration of the various temperature probes that have been used has not received the attention it should. To be accurate, all temperature sensors must be calibrated against a known standard. However, only short-term stability is checked during calibration. Long-term stability should be monitored and determined by the user through periodic regular comparisons with standards of higher accuracy. The frequency of such checks should be governed by experience, recognizing the potential fragility of many temperature probes.

The official temperature scale presently in use is the International Temperature Scale of 1990 (ITS-90)<sup>4</sup>. Although this is intended to represent closely *thermodynamic temperature* over a wide range of temperatures, it is first and foremost a temperature scale that can be realized in practice. It achieves this by assigning temperatures to particular fixed points such as the triple point of water: 273.16 K (0.01°C), or the triple point of gallium: 302.9146 K (29.7646°C), as well as defining appropriate interpolating equations based (for the oceanographic temperature range) on the properties of a standard platinum resistance thermometer.

Typically, working thermometer probes<sup>5</sup> are calibrated (at a number of different temperatures over the desired range of use) by placing them in a stable

<sup>4</sup> For additional information, see <http://www.its-90.com>.

<sup>5</sup> For high-quality measurements it is appropriate to recognize that what is typically needed is not just a calibration of the thermometer probe, but rather of the entire temperature measuring system (probe and readout).

temperature environment (*e.g.*, a temperature-controlled water bath) where their reading can be compared with the temperature value obtained using a reference thermometer whose own calibration is traceable to ITS-90. A good rule-of-thumb is that the uncertainty of this reference thermometer should be about 4 times smaller than the uncertainty desired for the thermometer being calibrated. Usually the reference thermometer is itself calibrated annually at an accredited calibration facility. The stability of a probe can be ascertained by monitoring its performance at a single temperature. (As is noted in the next section, it is important—for quality assurance purposes—to document the calibration of any thermometer used in the measurements described in this Guide.)

## 5. Documentation

One aspect of quality assurance that merits emphasis is that of documentation. All data must be technically sound and supported by evidence of unquestionable reliability. While the correct use of tested and reliable procedures such as those described in Chapter 4 is, without doubt, the most important part of quality control, inadequate documentation can cast doubt on the technical merits and defensibility of the results produced. Accordingly, adequate and accurate records must be kept of:

- when the measurement was made (date and time of taking the sample as well as date and time of processing the sample; in special cases, geological age of sample);
- where the measurement was made (latitude, longitude of the sampling from the official station list);
- what was measured (variables/parameters, units);
- how the measurement was made (equipment, calibration, methodology *etc.*, with references to literature, if available);
- who measured it (name and institution of the Principal Investigator);
- publications associated (in preparation or submitted);
- data obtained;
- calculations;
- quality assurance support;
- relevant data reports.

Although good analysts have historically kept such documentation, typically in bound laboratory notebooks, current practices of data sharing and archiving of data at national and world data centers require that this documentation (known as metadata) be maintained in electronic format with the data. Without an accompanying electronic version of the metadata to document methods and QA/QC protocols, archived data are of limited use. The challenge of documenting changes in the Earth system that have been ongoing since before any measurements were done makes it particularly important that data collected at different times and places be comparable, and that archived data be sufficiently well documented to be usable for decades or longer.

## 6. Bibliography

- Dickson, A.G. 2001. Reference materials for oceanic CO<sub>2</sub> measurements. *Oceanography* **14**: 21–22.
- Dickson, A.G., Afghan, J.D. and Anderson, G.C. 2003. Reference materials for oceanic CO<sub>2</sub> analysis: a method for the certification of total alkalinity. *Mar. Chem.* **80**: 185–197.
- Dux, J.P. 1990. Handbook of Quality Assurance for the Analytical Chemistry Laboratory, 2nd edition, Van Nostrand Reinhold, New York, 203 pp.
- Feely, R.A., Sabine, C.L., Takahashi, T. and Wanninkhof, R. 2001. Uptake and storage of carbon dioxide in the ocean: The global CO<sub>2</sub> survey. *Oceanography* **14**: 18–32.
- SCOR. 1985. Oceanic CO<sub>2</sub> measurements. Report of the third meeting of the Working Group 75, Les Houches, France, October 1985.
- Taylor, J.K. (1987) Quality Assurance of Chemical Measurements. Lewis Publishers, Chelsea, 328 pp.
- Taylor J.K. and Oppermann, H.V. 1986. Handbook for the quality assurance of metrological measurements. National Bureau of Standards Handbook 145.
- UNESCO. 1991. Reference materials for oceanic carbon dioxide measurements. UNESCO Tech. Papers Mar. Sci. No. 60.
- Vijverberg F.A.J.M. and Cofino, W.P. 1987. Control procedures: good laboratory practice and quality assurance. ICES Techniques in Marine Science No. 6.

# Chapter 4

## Recommended standard operating procedures

Standard operating procedures (SOPs) describe the way specific operations or analytical methods should be carried out. They comprise written instructions which define completely the procedure to be adopted by an analyst to obtain the required result. This Guide contains SOPs that fall under three categories. SOPs with numbers 1–10 are procedures for sampling and analysis. SOPs with numbers 11–20 are procedures related to calibrations. SOPs with numbers 21 and higher are for computations and quality control. These procedures have been in use since the early 1990s and have been revised with accumulated experience and improved technology. These are the recommended standard procedures for those participating in the CLIVAR/CO<sub>2</sub> repeat hydrography program. Each SOP has a revision date and version number that should be cited when referencing a procedure in scientific publications. Procedures for reporting errors are given in Chapter 1.

Many of the SOPs contain example calculations. Our philosophy on the precision given in these is that the answers should be correct whether the later steps are done from the partially rounded intermediate values shown, or all steps are done directly from the input data without rounding. However, there may be a few cases where the final result will be different depending on which of these two approaches is used.

### 1. Procedures for sampling and analysis

- SOP 1 Water sampling for the parameters of the oceanic carbon dioxide system
- SOP 2 Determination of total dissolved inorganic carbon in sea water
- SOP 3a Determination of total alkalinity in sea water using a closed-cell titration
- SOP 3b Determination of total alkalinity in sea water using an open-cell titration
- SOP 4 Determination of  $p(\text{CO}_2)$  in air that is in equilibrium with a discrete sample of sea water
- SOP 5 Determination of  $p(\text{CO}_2)$  in air that is in equilibrium with a continuous stream of sea water

- SOP 6a Determination of the pH of sea water using a glass/reference electrode cell
- SOP 6b Determination of the pH of sea water using the indicator dye *m*-cresol purple
- SOP 7 Determination of dissolved organic carbon and total dissolved nitrogen in sea water

**2. Procedures for calibrations, etc.**

- SOP 11 Gravimetric calibration of the volume of a gas loop using water
- SOP 12 Gravimetric calibration of volume delivered using water
- SOP 13 Gravimetric calibration of volume contained using water
- SOP 14 Procedure for preparing sodium carbonate solutions for the calibration of coulometric  $C_T$  measurements

**3. Procedures for computations, quality control, etc.**

- SOP 21 Applying air buoyancy corrections
- SOP 22 Preparation of control charts
- SOP 23 Statistical techniques used in quality assessment
- SOP 24 Calculation of the fugacity of carbon dioxide in pure carbon dioxide gas or in air



# SOP 1

## Water sampling for the parameters of the oceanic carbon dioxide system

### 1. Scope and field of application

This SOP describes how to collect discrete samples, from a Niskin or other water sampler, that are suitable for the analysis of the four measurable inorganic carbon parameters: total dissolved inorganic carbon, total alkalinity, pH and CO<sub>2</sub> fugacity.

### 2. Principle

A sample of sea water is collected in a clean glass container in a manner designed to minimize gas exchange with the atmosphere (note: CO<sub>2</sub> exchange affects the various carbon parameters to differing degrees ranging from the very sensitive CO<sub>2</sub> fugacity,  $f(\text{CO}_2)$ , to alkalinity which is not affected by gas exchange). The sample may be treated with a mercuric chloride solution to prevent biological activity, and then the container is closed to prevent exchange of carbon dioxide or water vapor with the atmosphere.

### 3. Apparatus

The sample containers are somewhat different depending on which parameter is being collected, but the basic concept is similar for the four possible inorganic carbon samples. In general, one needs a flexible plastic drawing tube, a clean<sup>1</sup> glass sample container with stoppers, a container and dispenser for the mercuric chloride solution (if it is being used) and a sampling log to record when and where each of the samples were collected.

#### 3.1 Drawing tube

Tygon<sup>®</sup> tubing is normally used to transfer the sample from the Niskin to the sample container; however, if dissolved organic carbon samples are being collected from the same Niskins, then it may be necessary to use silicone tubing to prevent contamination from the Tygon<sup>®</sup>. The drawing tube can be pre-treated

---

<sup>1</sup> Cleaning sample containers by precombustion in a muffle furnace will remove any organic carbon and associated microorganisms. Some groups soak the bottles in 1 N HCl; however, care must be taken to remove all residual acid during rinsing.

by soaking in clean sea water for at least one day. This minimizes the amount of bubble formation in the tube when drawing a sample.

### 3.2 Sample container

The sample container depends on the parameter being measured. Typically, the  $f(\text{CO}_2)$  samples are analyzed directly from the sample container so they are collected in 500 cm<sup>3</sup> volumetric flasks that have been pre-calibrated for a documented volume and sealed with screw caps that have internal plastic conical liners. Samples for pH are also typically analyzed directly from the sample containers. For spectrophotometric pH measurements, the samples are collected directly into 10 cm path-length optical cells and sealed with polytetrafluoroethylene (Teflon<sup>®</sup>) caps ensuring that there is no headspace. For  $C_T$  and  $A_T$ , high quality borosilicate glass bottles, such as Schott Duran (l.c.e.  $32 \times 10^{-7} \text{ K}^{-1}$ ), are recommended for both temporary and longer term storage. The bottles should be sealed using greased ground glass stoppers held in place with some form of positive closure, or in some alternate gas-tight fashion<sup>2</sup>.

### 3.3 Mercury dispenser

The  $f(\text{CO}_2)$  and  $C_T$  samples should be poisoned with a mercuric chloride solution at the time of sampling. The  $A_T$  samples have historically been poisoned as well, but tests have suggested that poisoning may not be required if open ocean samples are kept in the dark at room temperature and are analyzed within 12 hours. Samples for pH are typically not poisoned because the sample size is relatively small and the samples are usually analyzed very quickly after sampling. Although any appropriately sized Eppendorf pipette can be used to add the mercuric chloride solution, it may be more convenient to use a repipetter that can be mounted near the sample collection area. All equipment should be properly labeled for safety.

## 4. Reagents

### 4.1 Mercuric chloride solution

Samples collected for  $f(\text{CO}_2)$ ,  $C_T$ , and, in some cases,  $A_T$ , should be poisoned with a mercuric chloride solution to stop biological activity from altering the carbon distributions in the sample container before analysis. A typical solution is saturated mercuric chloride in deionized water. However, saturated solutions have been known to clog the pipette in very cold weather, so some investigators use twice the volume of a 50% saturated solution. Standard volumes used for saturated solutions are 0.05–0.02% of the total sample volume.

---

<sup>2</sup> Some groups use screw-cap bottles with apparent success, but this method has not been thoroughly tested and should not be used if samples are to be stored for extended periods.

## 4.2 Stopper grease

$C_T$  and  $A_T$  samples are typically collected in borosilicate glass bottles with ground glass stoppers. To form an airtight seal, the stoppers should be greased. Apiezon<sup>®</sup> L grease has been found to be suitable for this purpose; other greases may also work. Care should be taken not to transfer the grease onto the Niskin bottle as this could interfere with other analyses.

## 5. Procedure

### 5.1 Introduction

Collection of water at sea from the Niskin bottle (or other sampler) must be done soon after opening the sampler and before much other water has been removed from it. This is necessary to minimize exchange of  $\text{CO}_2$  with the air space in the sampler which affects all carbon parameters except  $A_T$ . Other gas samples (*e.g.*, He, CFCs,  $\text{O}_2$ ) have faster exchange rates than  $\text{CO}_2$  and are usually sampled before carbon, but it is desirable that the carbon samples be collected before the Niskin bottle is half empty and within 10 minutes of it being first opened. A typical sampling order for carbon is  $f(\text{CO}_2)$ , pH,  $C_T$ , then  $A_T$ .

### 5.2 Filling procedure

*Rinse the sample bottle* — If the bottle is not already clean, rinse it twice with 30–50  $\text{cm}^3$  of sample to remove any traces of a previous sample.

*Fill the sample bottle* — Fill the bottle smoothly from the bottom using a drawing tube which extends from the Niskin drain to the bottom of the glass sample bottle. For  $f(\text{CO}_2)$ , pH, and  $C_T$ , it is critical to remove any bubbles from the draw tube before filling. Overflow the water by at least a half, and preferably by a full, bottle volume<sup>3</sup>.

*Adjust the headspace* — A headspace of 1% of the bottle volume is left to allow for water expansion (see Annexe to this procedure), *i.e.*, 2.5  $\text{cm}^3$  for a 250  $\text{cm}^3$  bottle. This can be achieved by pinching off the draw tube before removing it from the sample bottle or removing excess water using a plastic pipette with a bulb. pH samples should not have a headspace.

*Add mercuric chloride* — Mercuric chloride is added to poison the sample; the recommended minimum amount is about 0.02% by volume of a saturated aqueous solution. Thus to poison a 250  $\text{cm}^3$  sample requires 0.05  $\text{cm}^3$  (50  $\mu\text{l}$ ) of saturated mercuric chloride (or 0.10  $\text{cm}^3$  of a 50% saturated solution). Maximum amount is 0.1% by volume of a saturated aqueous solution, or a smaller percentage than measurement precision of  $C_T$  and  $f(\text{CO}_2)$ .

---

<sup>3</sup> The amount of overflow water can be estimated by measuring how long it takes to fill a sample bottle, and allowing the water to flow for a period of 1.5 times that.

*Close the bottle* — Seal the bottle carefully to ensure that it remains gas-tight. If it is to be sealed using a greased ground glass stopper<sup>4</sup>, first wipe the excess water from the ground glass in the bottle neck, then insert the stopper completely, and finally twist the stopper to squeeze the air out of the grease to make a good seal.

*Finally, secure the lid* — Use a rubber band or other positive closure, then invert the bottle several times to disperse the mercuric chloride solution thoroughly.

### 5.3 Sample storage

The samples should be stored in a cool, dark, location (preferably refrigerated but not frozen) until use.

### 5.4 Sample documentation

The following information must be recorded in the sampling logbook at the time of sampling:

- Time and date when taken;
- Full name of person who took sample;
- Location: an unambiguous designation of the station, cast, and bottle number from which the sample was taken;
- Container designation: a number or alphanumeric symbol unique to the sample container;
- Comments: additional information such as conditions when sampling, problems with sample collection, *etc.*

## 6. Quality assurance

Some duplicate sampling is recommended, both from the same sampler (*e.g.*, Niskin bottle) and, if possible, from two samplers tripped together at the same depth, to assess the quality of the sampling procedures.

---

<sup>4</sup> The recommended procedure for re-greasing (or greasing) a stopper is as follows: (a) wipe the stopper with a tissue to remove as much grease as possible and (b) grease the stopper with 4 strips of grease, each strip extending two thirds of the way from the top towards the bottom of the ground portion of the stopper. This provides a path for air to escape when the stopper is inserted into the neck of the bottle.

## Annexe

### How large a headspace should be left in a sample bottle?

The volume of the headspace is chosen so as to leave room for expansion of the sea water on warming, while being sufficiently small to minimize the amount of gas exchange between the headspace and the bulk of the sample. The closure system must be adequate to retain the pressure exerted by the expansion.

The apparent change in the volume of a fixed mass of sea water can be calculated by allowing for the change in the density of the sea water and the expansion of the glass container. The total change over the temperature range 0–40°C is about 1%. (The effect of expansion on the volume of the borosilicate glass bottle is only 0.04% over this range.) One third of this expansion occurs on heating the sea water from 0 to 20°C, the remaining two thirds on heating it from 20 to 40°C.

The pressure in the headspace of a container heated from a temperature  $t_1$  to  $t_2$  can be estimated, allowing for the following:

- the expansion of the sea water in the bottle,
- the change in solubility of gases such as  $N_2$ ,  $O_2$ , Ar,
- the thermal expansion of the gas phase,
- the change in the vapor pressure of  $H_2O$  in the gas phase.

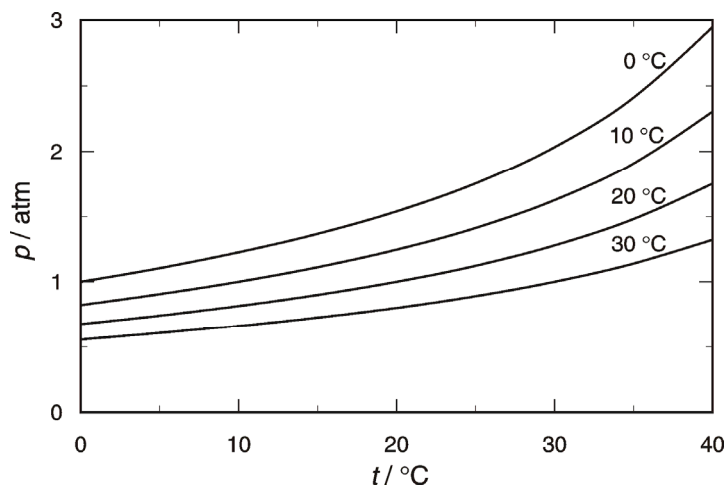

**Fig. 1** Pressure in headspace with  $r = 0.01$  as a function of temperature for various initial temperatures. In calculating this, it was assumed that the gases— $N_2$ ,  $O_2$ , Ar,  $H_2O$ —were initially at solubility equilibrium with sea water at the starting temperature, that they behaved ideally and that the initial pressure in the bottle at the indicated temperature was 1 atm.

Defining the initial headspace ratio,

$$r = \frac{V(\text{headspace})}{V(\text{sea water})}, \quad (1)$$

allows the calculation of the approximate pressure in the headspace of a closed container as a function of temperature. Clearly, if cold samples ( $< 10^\circ\text{C}$ ) are likely to be heated above  $30^\circ\text{C}$ , there is a risk of them leaking if the headspace ratio is significantly less than 1%. There is, however, an additional factor to be taken into account when determining the optimal headspace size: gas exchange with the headspace. The change in total dissolved inorganic carbon ( $\Delta C_T$ ) resulting from this gas exchange can be derived from mass balance considerations:

$$\Delta C_T = \frac{\left(\frac{p(\text{CO}_2)V}{T}\right)_{\text{initial}} - \left(\frac{p(\text{CO}_2)V}{T}\right)_{\text{final}}}{R \cdot m(\text{sample})} \quad (2)$$

where  $p(\text{CO}_2)$  is the partial pressure of  $\text{CO}_2$  in a headspace of volume  $V$  and at a temperature  $T$  corresponding to the initial condition (when the bottle is closed) and the final condition (when the bottle is analyzed),  $R$  is the gas constant and  $m(\text{sample})$  is the mass of the sample.

The volume of the headspace decreases as the contents heat up (due to the expansion of the sea water) partially compensating for the decrease in the solubility of the various gases, thus the greatest loss of  $\text{CO}_2$  will occur if the sea water has a high  $p(\text{CO}_2)$  but does not warm up significantly in the container. Even then, provided that the headspace ratio is less than 0.01,  $\Delta C_T$  will be less than  $0.5 \mu\text{mol kg}^{-1}$ .

Gain or loss of  $\text{CO}_2$  gas is not significant when collecting discrete samples for alkalinity measurement; however, if  $p(\text{CO}_2)$  is to be measured, the so-called “buffer factor” comes into play and the resultant relative error in  $p(\text{CO}_2)$  is approximately 10 times that in  $C_T$ , *i.e.*, for a change of  $-0.5 \mu\text{mol kg}^{-1}$  in  $C_T$ , the change in  $p(\text{CO}_2)$  is about  $-0.25\%$ . This corresponds to a change in pH of about  $+0.001$ .

A headspace of 1% is thus optimal for the collection of  $\text{CO}_2$  samples, provided that they will not be exposed to temperature changes of  $30^\circ\text{C}$  or more. If this cannot be assured, it is preferable to allow a larger headspace and to estimate the appropriate correction.

# SOP 2

## Determination of total dissolved inorganic carbon in sea water

### 1. Scope and field of application

This procedure describes a method for the determination of total dissolved inorganic carbon in sea water, expressed as moles of carbon per kilogram of sea water. The method is suitable for the assay of oceanic levels of total dissolved inorganic carbon (1800–2300  $\mu\text{mol kg}^{-1}$ ) and also for higher levels such as are found in the Black Sea (3800–4300  $\mu\text{mol kg}^{-1}$ ).

### 2. Definition

The total dissolved inorganic carbon content of sea water is defined as

$$C_T = [\text{CO}_2^*] + [\text{HCO}_3^-] + [\text{CO}_3^{2-}] \quad (1)$$

where brackets represent total concentrations of these constituents in solution (in  $\text{mol kg}^{-1}$ ) and  $[\text{CO}_2^*]$  represents the total concentration of all unionized carbon dioxide, whether present as  $\text{H}_2\text{CO}_3$  or as  $\text{CO}_2$ .

### 3. Principle

A known amount of sea water is dispensed into a stripping chamber where it is acidified and purged with an inert gas. The presence of solid carbonates, such as  $\text{CaCO}_3$ , thus constitutes an interference in the method. The amount of  $\text{CO}_2$  in the resulting gas stream is determined by trapping the  $\text{CO}_2$  in an absorbent containing ethanolamine and titrating coulometrically the hydroxyethylcarbamic acid that is formed. The pH of the solution is monitored by measuring the transmittance of thymolphthalein indicator at approximately 610 nm. Hydroxide ions are generated by the coulometer circuitry so as to maintain the transmittance of the solution at a constant value. The relevant chemical reactions occurring in the solution are

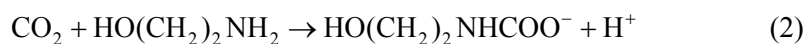

and



The hydroxide ions used are generated at the cathode by electrolyzing water:

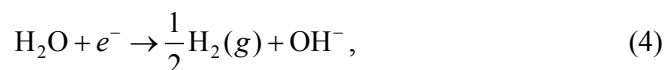

while silver is dissolved at the anode:

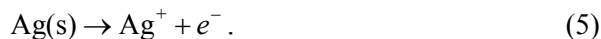

The overall efficiency of the coulometric procedure is calibrated using known amounts of CO<sub>2</sub> gas or from Na<sub>2</sub>CO<sub>3</sub> solutions.

## 4. Apparatus

In the late 1980s, a system called the Single Operator Multi-parameter Metabolic Analyzer (SOMMA) was developed to interface with a coulometer to make high precision  $C_T$  measurements (Johnson *et al.*, 1985; 1987; 1993). The system was produced commercially for a few years in the early 1990s and became the standard for automated coulometric  $C_T$  measurements. The original manufacturer of the SOMMA system is no longer in operation, but this approach still represents the most common technique for  $C_T$  measurements.

### 4.1 Sea water dispensing system

This is used to dispense an accurately known amount of sea water from the sample bottle into the extraction system without allowing any significant exchange of CO<sub>2</sub> with the atmosphere<sup>1</sup>. If a controlled volume of water is dispensed, its temperature must be known to within  $\pm 0.4^\circ\text{C}$ .

### 4.2 CO<sub>2</sub> extraction system

The sea water is reacted with phosphoric acid in a borosilicate glass stripping chamber equipped with a drain for removing spent sample. The solution is stripped of CO<sub>2</sub> by bubbling the carrier gas through a fine frit submerged in the acidified sample. Carrier gas leaving the stripping chamber is treated to prevent acid droplets from reaching the coulometer cell.

### 4.3 Coulometer system

A UIC Model 5011 or 5012 CO<sub>2</sub> coulometer (UIC Inc., P.O. Box 863, Joliet, IL 60434, U.S.A.) is the most common system used. This system uses a coulometer cell with a platinum spiral cathode and silver rod anode (both available from UIC). It is desirable to control the temperature of this cell to within  $\pm 0.2^\circ\text{C}$ . The pK of the indicator used to sense pH in the solution is temperature sensitive; a substantial change in temperature between the beginning and end of

---

<sup>1</sup> There are two principal means of achieving this: (a) using a syringe modified to deliver a controlled volume through a septum port into the extraction vessel (on land the amount of water dispensed can be determined by weighing the syringe before and after dispensing the sample); (b) using a calibrated pipette closed with valves at each end—this approach is taken on the SOMMA system.



an analysis will cause an error. The magnitude of this error is about 200 counts per degree Celsius per 100 cm<sup>3</sup> of cathode solution. Although this is rarely significant for a sea water sample, it complicates accurate measurement of the background titration rate.

#### 4.4 Gas loop calibration system

This is not essential to the operation of the coulometer, as the instrument can be calibrated successfully using carefully prepared solutions of sodium carbonate. It is, however, the most common way of calibrating the system and is strongly recommended. Typically, two stainless steel loops of a known volume (within  $\pm 0.02\%$ )<sup>2</sup> are mounted to an 8-port chromatography valve<sup>3</sup> inside of an enclosure to control the temperature. Thermometers accurate to  $\pm 0.05^\circ\text{C}$  and a barometer accurate to  $\pm 20$  Pa ( $\pm 0.2$  mbar) are necessary to determine the number of moles of gas in the loops at the time of calibration.

#### 4.5 Computer control

Although computer control is not essential for this procedure, it simplifies the operation of the instrument significantly and allows experimental results to be available immediately for quality assessment. If a computer is used, it should be interfaced so as to acquire the data from the coulometer. It is also possible to automate the sample dispensing and stripping system, as well as to operate the gas loop calibration system (if present), and to acquire the related temperature and pressure information.

### 5. Reagents

#### 5.1 Compressed gases

A CO<sub>2</sub> free carrier gas stream is needed to transfer the CO<sub>2</sub> from the stripper to the coulometer cell. This gas can be produced locally using a pure air generator, or dispersed from a compressed gas cylinder (*e.g.*, nitrogen > 99.995% pure). A standard “A cylinder” of carrier gas will last approximately 3 weeks with continuous use on a SOMMA system under normal operating conditions. If gas loops are used for calibration, then a small cylinder (*e.g.*, Scotty 48 cylinder) of pure (> 99.99% pure) carbon dioxide is needed.

#### 5.2 Removal of CO<sub>2</sub> from the carrier gas

The carrier gas is run through a column of CO<sub>2</sub> absorbent (*e.g.*, Ascarite II<sup>®</sup> or Malcosorb<sup>®</sup>) to ensure that there is no CO<sub>2</sub> in the stream as this will affect the cell blank. If the carrier gas is truly CO<sub>2</sub>-free, then these chemicals should not need to be replaced very frequently.

---

<sup>2</sup> The loops can be calibrated with water while mounted on the valve (see SOP 11).

<sup>3</sup> A plumbing diagram for the Valco 8-port valve (W type) is shown in the Annexe to this procedure.

### 5.3 Acidification of sample

Reagent grade phosphoric acid is needed to acidify the sample in the stripping chamber. Typically 85% acid is diluted with deionized water by a factor of 10:1 (to ~ 8.5%). Approximately 1.5 cm<sup>3</sup> of diluted acid is used per sample.

### 5.4 Sample gas stream purification

After the CO<sub>2</sub> is removed from the sea water sample in the stripper, the excess water vapor and non-CO<sub>2</sub> acid gases must be removed (see section 4.2). This is accomplished in the SOMMA system with a cold condensing chamber followed by a chemical column of Dehydrite<sup>®</sup> (magnesium perchlorate) to remove the water vapor, then a column of activated silica gel, ORBO-53<sup>®</sup> from Supelco, Inc., to trap the non-CO<sub>2</sub> acid vapors<sup>4</sup>.

For samples that contain H<sub>2</sub>S, an additional scrubber is needed. Dissolve 3 g of silver nitrate (AgNO<sub>3</sub>) into 100 cm<sup>3</sup> of deionized water. Acidify the solution to approximately pH 3 by adding several drops of 70% sulfuric acid. When using this scrubber solution, add approximately 1 cm<sup>3</sup> of 30% hydrogen peroxide (H<sub>2</sub>O<sub>2</sub>) to 15 cm<sup>3</sup> of scrubber solution on a daily basis. The precipitate formed in this solution by the absorption of H<sub>2</sub>S or SO<sub>2</sub> is black in color. This scrubber will also remove halogens. The precipitate of halogens will generally be dull gray or yellowish in color.

### 5.5 Coulometer cell solutions

The primary chamber of the coulometer cell is filled with approximately 100 cm<sup>3</sup> of cathode solution (available from UIC Inc.), a proprietary mixture which contains water, ethanolamine, tetra-ethyl-ammonium bromide, and thymolphthalein in solution in dimethyl sulfoxide (DMSO)<sup>5</sup>. The side arm of the coulometer cell is filled with anode solution (available from UIC Inc.) to be approximately 1 cm below the liquid level of the cathode solution. The anode solution contains saturated potassium iodide in water and DMSO. To ensure that the anode solution remains saturated, reagent-grade potassium iodide crystals are added to the side arm of the coulometer cell.

---

<sup>4</sup> Several methods are in use for this. The SOMMA employs a water-jacketed condenser, a tube of drying agent and an activated silica gel trap in series; other investigators prefer to remove aerosols from the gas stream by impacting them either on Pyrex<sup>®</sup> wool or on a Teflon<sup>®</sup> filter, rather than removing them by chemical means.

<sup>5</sup> DMSO and ethanolamine are potentially hazardous chemicals and should be handled and disposed of appropriately. The vapor leaving the coulometer cell contains significant amounts of these chemicals; they can be removed from the gas stream using an activated charcoal trap; however, care must be taken to avoid restricting flow through this trap, thus pressurizing the cell and causing flow through the frit separating the anode and cathode compartments.

## 6. Sampling

It is essential that the samples to be analyzed are collected, poisoned and stored according to the procedure detailed in SOP 1. Care must be taken to avoid the exchange of CO<sub>2</sub> with the atmosphere during both sampling and subsequent manipulation. When using a 36 place rosette to sample the water column, it is recommended that 3 sets of duplicate samples be collected. One set of duplicates is collected in the deep water, one is collected near the surface, and one set is collected at intermediate depths (typically near the oxygen minimum zone). Analysis of these duplicates is interspersed in the analysis sequence to confirm the stability of the cell.

## 7. Procedure

### 7.1 Introduction

An analysis session, starting with fresh solutions in the coulometer<sup>6</sup>, consists of the sequence of activities outlined in Table 1. At each stage of this procedure, compare the results obtained with the system's previous history to ensure that the method is performing according to prescribed specifications (see section 9). Once the initial tests are complete, water samples can be analyzed. The calibration factor is verified during the course of the sequence of analyses and again at the end before the cell solutions are discarded<sup>7</sup>.

**Table 1** Recommended sequence of activities in an analysis session.

Activity	Section
Document pipette delivery volume (beginning of cruise)	SOP 12
Fill cell with fresh anode and cathode solutions	5.5
Two "junk" sea water samples (to condition system)	7.5
Background level determination	7.3
Full calibration	7.4
Analyze sea water reference material	7.5
Analyze samples	7.5
Confirm calibration either with loops, reference material, or with sample duplicates	7.4, 7.5
Analyze further samples	7.5
Confirm calibration either with loops, reference material, or with sample duplicates	7.4, 7.5
Discard cell solutions	Footnote 5
Clean cell and electrodes	7.6

<sup>6</sup> Ideally, the coulometer should be left on at all times to avoid problems with drift and temperature stability of the electronics. For optimal stability, the maximum current of the system is adjusted to 50 mA (see coulometer instruction manual).

<sup>7</sup> The cell solutions should be replaced either after 12 hours of use, after a cumulative total of 2 mmol CO<sub>2</sub> have been titrated, or after the change in calibration factor is considered excessive (see section 9). The cell solutions should be disposed of safely (see Footnote 5).

## 7.2 Check of sea water dispensing system calibration

At the beginning of a cruise, after the system has been set up on the ship, and again at the end of a cruise, before the system is packed away, the pipette delivery volume should be confirmed by collecting several replicate samples that can be returned to the shore-based laboratory to be weighed. Deliver an aliquot of deionized water into a pre-weighed serum bottle using the dispensing system. Seal the bottle and save it to be reweighed later (on return to shore). Comparison of the results from replicate analyses using alternate dispensers can be used to detect discrepancies on board ship. Analyses of a reference material will also indicate if problems exist.

## 7.3 Determination of the background level

Run CO<sub>2</sub> free carrier gas through the extraction system and into the cell of the coulometer. Once the background titration rate is stable, determine the background level by summing the total number of counts on the coulometer over a 10-minute period. If the background level is within the specified tolerance (see section 9), note its value and begin the various analyses. If the background level is too high, run another background check or troubleshoot the system.

## 7.4 Determination of the calibration factor for the coulometer

The electrical calibration of the coulometer is not perfectly accurate (see SOP 14) and the current efficiency of the electrode processes occurring in the coulometer cell has been shown to vary from 100%; it is therefore preferable to calibrate the coulometer for each set of samples (*i.e.*, for each fresh set of cell solutions) and to confirm the calibration regularly (after every 10 to 12 water samples or every 4 hours, whichever is sooner). There are two principal means of achieving this: using a known amount of pure CO<sub>2</sub> gas dispensed from a calibrated gas loop at a known temperature and pressure, or using aqueous solutions of sodium carbonate which are treated as if they were samples. Both approaches are described here<sup>8</sup>.

*Calibration using gas loops* — Stainless steel loops of a known volume are incorporated into a chromatography valve that can be controlled from a computer. Fill the loop with pure CO<sub>2</sub> gas and allow the temperature and pressure to equilibrate. Measure temperature and pressure and turn the valve to allow the contents of the loop to be flushed with carrier gas into the coulometer cell. Record the final coulometer reading when the coulometer titration rate returns to the background level.

---

<sup>8</sup> The relative merits of these two approaches are still debated. Gas loops are difficult to calibrate initially (see Wilke *et al.*, 1993 and SOP 11) and their use requires accurate measurement of temperature and pressure (see section 4.4), but once in place they are particularly convenient as a means to calibrate the coulometer response alone (*i.e.*, not the volume delivery or extraction efficiency). Sodium carbonate solutions need to be prepared frequently and it is desirable to use a series of them for each calibration. The apparatus required is inexpensive and using such solutions calibrates the entire system response: delivery volume, extraction efficiency, and coulometer response.

The mean calibration factor—calculated as in section 8.2—obtained from a pair of loops that bracket the range of CO<sub>2</sub> present in the samples, is used for calibration purposes. The value of the calibration factor can be confirmed using a single loop. Compare the results obtained with those obtained previously to ensure that the system remains within tolerances (see section 9).

*Calibration using sodium carbonate solutions* — Sodium carbonate solutions (see SOP 14 for preparation procedure) are treated like sea water samples (see section 7.5). It is desirable to use a suite of solutions to measure the calibration factor<sup>9</sup> although a single solution can be used to confirm the constancy of the calibration factor during a run. Compare the results—calculated as in section 8.2—with those obtained previously to ensure that the system remains within tolerances (see section 9).

### 7.5 Analysis of a sea water sample

Once the background level and calibration factor have been determined satisfactorily, use the system to analyze sea water samples. Handle the water samples so as to minimize CO<sub>2</sub> exchange between the water sample and any headspace.

Dispense the sample (~ 30 cm<sup>3</sup>) into the stripping chamber and acidify it with phosphoric acid (~ 1.5 cm<sup>3</sup>). Ensure that the sample delivery system is rinsed adequately with fresh sample. The phosphoric acid must either be CO<sub>2</sub> free<sup>10</sup> or an acid blank correction must be determined. Record the final coulometer reading when the coulometer titration rate returns to the background level.

The temperature of the sample on delivery ( $\pm 0.4^\circ\text{C}$ ) and its salinity ( $\pm 0.1$ ) are needed to compute the sample density.

### 7.6 Cleaning the apparatus

Clean the sea water dispensing and stripping systems by rinsing thoroughly with deionized water. Clean the coulometer cell by rinsing first with acetone and then with deionized water, taking care to force these solvents through the frit. If the frit is particularly dirty, it may be necessary to clean the cell with *aqua regia* and then to rinse it thoroughly with deionized water. Rinse and dry the cell cap and electrodes. Place the dried cell and cap in an oven at 50°C for 12 hours before use.

The platinum cathode should be rinsed in nitric acid occasionally to remove any deposits of silver, and the silver anode should be abraded with glass wool to remove any deposits of silver iodide.

---

<sup>9</sup> Because of the experimental problems inherent in weighing and transferring small amounts of Na<sub>2</sub>CO<sub>3</sub> crystals, and because of the ubiquitous CO<sub>2</sub> background in deionized water, it is typically not possible to make up a single solution with an uncertainty of less than 1  $\mu\text{mol kg}^{-1}$ . By using a series of such solutions, the resultant error in the calibration factor is minimized.

<sup>10</sup> If the acid is dispensed into the stripping cell prior to the addition of sea water, it can be purged of CO<sub>2</sub> *in situ*.

## 8. Calculation and expression of results

### 8.1 Calculation of the background titration rate

Compute the background titration rate—expressed in counts  $\text{min}^{-1}$ :<sup>11</sup>

$$b = \frac{N_b}{10} \quad (6)$$

where

$N_b$  = the coulometer reading for a 10-minute period (counts).

### 8.2 Calculation of the calibration factor

#### 8.2.1 Based on a single loop

Compute the calibration factor ( $c$ )—expressed in counts  $\text{mol}^{-1}$ —from the coulometer reading for the analysis of  $n(\text{CO}_2)$  moles of  $\text{CO}_2$  dispensed from a gas loop of known volume, at a known temperature and pressure:

$$c = \frac{N_c - bt}{n(\text{CO}_2)} \quad (7)$$

where

$N_c$  = the coulometer reading for the gas sample (counts),

$b$  = the background level of the system (counts  $\text{min}^{-1}$ ),

$t$  = the time required to measure that sample (min),

$n(\text{CO}_2)$  = the amount of  $\text{CO}_2$  dispensed from the loop (mol),

$$n(\text{CO}_2) = \frac{V(T)}{V(\text{CO}_2)}. \quad (8)$$

$V(T)$  is the volume of the loop at the calibration temperature  $T$  (see SOP 11, section 4.4);  $V(\text{CO}_2)$  is the molar volume of pure  $\text{CO}_2$  at the temperature ( $T$ ) and pressure ( $p$ ) of the calibration and is calculated iteratively from the expression

$$V(\text{CO}_2) = \frac{RT}{p} \left( 1 + \frac{B(\text{CO}_2, T)}{V(\text{CO}_2)} \right). \quad (9)$$

Values of the virial coefficient  $B(\text{CO}_2, T)$  are given by the expression

$$\frac{B(\text{CO}_2, T)}{\text{cm}^3 \text{ mol}^{-1}} = -1636.75 + 12.0408 \left( \frac{T}{\text{K}} \right) - 3.27957 \times 10^{-2} \left( \frac{T}{\text{K}} \right)^2 + 3.16528 \times 10^{-5} \left( \frac{T}{\text{K}} \right)^3 \quad (10)$$

where  $265 < T/\text{K} < 320$  (see Chapter 5 for check value).

<sup>11</sup> The unit counts (mode 0) corresponds to the most sensitive setting of the coulometer. The results obtained using other settings, such as  $\mu\text{g C}$  (e.g., mode 2), can also be interpreted as arbitrary units for use in these equations.

If the calibration factors from the two loops agree well (see section 9), they should be averaged to give a mean calibration factor for use in further computations.

### 8.2.2 Based on a series of sodium carbonate solutions (SOP 14)

The calibration factor,  $c$ , is computed from the results obtained for a series of sodium carbonate solutions:

$$\frac{N_S - b \cdot t - a}{V_S} = c \cdot dw + c \cdot M \quad (11)$$

where

- $N_S$  = the coulometer reading for the  $\text{Na}_2\text{CO}_3$  sample (counts),
- $a$  = the acid blank (counts),<sup>12</sup>
- $b$  = the background level of the system (counts  $\text{min}^{-1}$ ),
- $t$  = the time required to measure the  $\text{Na}_2\text{CO}_3$  sample (min),
- $V_S$  = the volume<sup>13</sup> of the  $\text{Na}_2\text{CO}_3$  sample ( $\text{dm}^3$ ),
- $dw$  = the background level of  $\text{CO}_2$  in the deionized water used to prepare the samples ( $\text{mol dm}^{-3}$ ),
- $M$  = the nominal concentration of the  $\text{Na}_2\text{CO}_3$  sample ( $\text{mol dm}^{-3}$ ) computed from the mass of  $\text{Na}_2\text{CO}_3$  used (see SOP 14).

The calibration factor,  $c$ , is computed as the slope of the straight line (11); its associated uncertainty is given by the standard error of the slope (see SOP 23). The intercept gives the deionized water “blank”:  $dw$ . A prior knowledge of the value for  $dw$  thus does not play a role in the determination of the calibration factor; its uncertainty is averaged over all the standard solutions (including a solution where  $M = 0 \text{ mol dm}^{-3}$ ).

### 8.3 Calculation for a sea water sample

Calculate the total dissolved inorganic carbon in a sea water sample:

$$C_T' = \frac{N_S - b \cdot t - a}{c} \cdot \frac{1}{V_S \cdot \rho} \quad (12)$$

The various terms are:

- $C_T'$  = the total dissolved inorganic carbon in the sample ( $\text{mol kg}^{-1}$ ),
- $N_S$  = the coulometer reading for the sea water sample (counts),
- $a$  = the acid blank<sup>12</sup> (counts),
- $b$  = the background level of the system (counts  $\text{min}^{-1}$ ),
- $c$  = the coulometer calibration factor (counts  $\text{mol}^{-1}$ ),
- $t$  = the time required to measure the water sample (min),

<sup>12</sup> If a SOMMA system is used, the acid is added to the extraction cell and then stripped of  $\text{CO}_2$  before commencing an analysis, *i.e.*,  $a = 0$ .

<sup>13</sup> A comparison of equations (11) and (12) shows that if  $V_S$  is assumed to be the same in both equations, errors in the calibration of pipette volume cancel out. Note that this assumes that the  $\text{Na}_2\text{CO}_3$  solution and the sea water are delivered at the same temperature.

$V_s$  = the volume of the sea water sample at the temperature of use ( $\text{dm}^3$ ) (SOP 12). (If  $\text{Na}_2\text{CO}_3$  solutions were used for calibration, see Footnote 13.)  
 $\rho$  = the density of the sea water sample ( $\text{g cm}^{-3}$ ) (see Chapter 5).

For the most accurate work, two further minor corrections may need to be made to compute the total dissolved inorganic carbon in the original sea water sample: for the dilution by mercuric chloride when the sample was collected<sup>14</sup> and for the exchange of  $\text{CO}_2$  with the headspace in the sampling bottle<sup>15</sup>:

$$C_T = 1.0002(C'_T - \Delta C_T) \quad (13)$$

where  $\Delta C_T$  is the change in  $C_T$  resulting from exchange with the headspace of the bottle. Provided that  $r$  is less than 1%, this correction will always be less than  $0.5 \mu\text{mol kg}^{-1}$ .

## 8.4 Example calculation<sup>16</sup>

### 8.4.1 Calculation of the blank

$N_b$  = 100 counts in 10 minutes,  
 $b$  =  $100 / 10$   
 = 10 counts  $\text{min}^{-1}$ .

### 8.4.2 Calculation of the calibration factor for a single loop

$T$  = 298.15 K,  
 $p$  = 101.325 kPa,  
 $V(298.15 \text{ K})$  =  $1.5000 \text{ cm}^3$ ,  
 $B(\text{CO}_2, 298.15 \text{ K})$  =  $-123.2 \text{ cm}^3 \text{ mol}^{-1}$ ,  
 $N_c$  = 294033 counts in 15 minutes.

Thus

$$V(\text{CO}_2) = 24341.6 \text{ cm}^3 \text{ mol}^{-1}$$

is calculated iteratively from (9) and

$$n(\text{CO}_2) = 1.5/24341.6 \text{ mol}$$

$$= 61.6229 \mu\text{mol}.$$

Hence

$$c = \frac{294033 - 10 \times 15}{61.6229 \times 10^{-6}}$$

$$= 4.7691 \times 10^9 \text{ counts mol}^{-1}.$$

<sup>14</sup> The value 1.0002 assumes that 0.02% by volume saturated mercuric chloride was used; if a 50% saturated solution was used to preserve the sample, the minimum volume is 0.04% (see SOP 1).

<sup>15</sup> See Annexe to SOP 1, equation (2).

<sup>16</sup> The apparent excess of significant figures is provided to aid in checking computer implementations of these computations.



### 8.4.3 Calculation of the calibration factor using 6 $\text{Na}_2\text{CO}_3$ solutions

$b = 10 \text{ counts min}^{-1}$ ;  $a = 40 \text{ counts}$ ;  $V_S = 27.0000 \text{ cm}^3$ ;

$$M_1 = 0.0 \text{ } \mu\text{mol dm}^{-3}; \quad N_S = 1892 \text{ counts in 15 min}$$

$$M_2 = 498.8 \text{ } \mu\text{mol dm}^{-3}; \quad N_S = 66537 \text{ counts in 15 min}$$

$$M_3 = 1001.9 \text{ } \mu\text{mol dm}^{-3}; \quad N_S = 130818 \text{ counts in 15 min}$$

$$M_4 = 1500.8 \text{ } \mu\text{mol dm}^{-3}; \quad N_S = 195216 \text{ counts in 15 min}$$

$$M_5 = 2002.5 \text{ } \mu\text{mol dm}^{-3}; \quad N_S = 260068 \text{ counts in 15 min}$$

$$M_6 = 2497.1 \text{ } \mu\text{mol dm}^{-3}; \quad N_S = 323456 \text{ counts in 15 min}$$

Linear regression (SOP 23) gives

$$\begin{aligned} \text{slope} &= 4.76908 \times 10^9 \text{ counts mol}^{-1}, \\ \text{intercept} &= 67695.1 \text{ counts dm}^{-3}. \end{aligned}$$

So, from (11),

$$c = 4.76908 \times 10^9 \text{ counts mol}^{-1}$$

and

$$dw = 14.195 \text{ } \mu\text{mol dm}^{-3}.$$

### 8.4.4 Calculation for a sea water sample

$S = 35.00$ ;  $t = 25.0^\circ\text{C}$ ;  $\rho(S, t) = 1.02334 \text{ g cm}^3$ ;

$$V_S = 27.0000 \text{ cm}^3,$$

$$a = 40 \text{ counts}; \quad b = 10 \text{ counts min}^{-1},$$

$$N_S = 289874 \text{ counts in 15 minutes.}$$

From (12),

$$\begin{aligned} C'_T &= \frac{289874 - 10 \cdot 15 - 40}{4.76908 \times 10^9} \cdot \frac{1}{27 \cdot 1.02334} \\ &= 2197.64 \text{ } \mu\text{mol kg}^{-1}. \end{aligned}$$

Correcting for the addition of mercuric chloride (0.02% of a saturated solution),

$$C_T = 2198.07 \text{ } \mu\text{mol kg}^{-1}.$$

## 9. Quality assurance

### 9.1 For general principles of analytical quality control see Chapter 3

### 9.2 Specific applications of analytical quality control

The various control limits outlined below are necessary to ensure that the accuracy and precision of the data are adequate. The targets that were set for the first world-wide  $\text{CO}_2$  survey were: a maximum within cruise precision (1 SD) of  $1.5 \text{ } \mu\text{mol kg}^{-1}$  and an overall between cruise (and between laboratory) range of

bias of less than  $4 \mu\text{mol kg}^{-1}$ . Results from a collaborative study of this method indicate that these targets are attainable.

Calculate preliminary results immediately and update the control charts outlined below as soon as possible. Maintain a logbook detailing all the analyses carried out and describing any adjustments made to the analytical system.

The following goals are recommended for various parameters.

### ***9.2.1 Stability and magnitude of the background level***

The background should be less than  $25 \text{ counts min}^{-1}$  ( $0.05 \mu\text{g C min}^{-1}$ ) and should remain stable to within  $\pm 10 \text{ counts min}^{-1}$ . Plot the values obtained for the background level on a property control chart (SOP 22).

### ***9.2.2 Agreement between gas loops of two different sizes***

The amounts of  $\text{CO}_2$  dispensed by the gas loops should be chosen to bracket the expected values obtained from samples. The two loops should provide the same calibration factor to within 0.05%.

### ***9.2.3 Quality of sodium carbonate calibration***

The computed relative standard error of the slope should be less than or equal to 0.05%.

### ***9.2.4 Stability of calibration factor***

The mean value from the pair of loops, or the slope of the line when using  $\text{Na}_2\text{CO}_3$ , should remain stable within 0.1%. Plot the results obtained on a property control chart (SOP 22).

### ***9.2.5 Analysis of a sea water reference material***

A stable reference material<sup>17</sup> should be analyzed regularly (at least once per filling of coulometer solution). Plot the results on a property control chart (SOP 22).

### ***9.2.6 Duplicate analyses***

A duplicate analysis should be made on every tenth sample. Plot the difference between each pair of analyses on a range control chart (SOP 22).

---

<sup>17</sup> Reference materials available from Dr. Andrew G. Dickson, Marine Physical Laboratory, Scripps Institution of Oceanography, University of California, San Diego, 9500 Gilman Drive, La Jolla, CA 92093-0244, U.S.A. (fax: 1-858-822-2919; e-mail: co2crms@ucsd.edu).

## 10. Bibliography

- Dickson, A.G. 1992. The determination of total dissolved inorganic carbon in sea water. The first stage of a collaborative study. U.S. Department of Energy No. DOE/RL/01830T-H14.
- Huffman, Jr., E.W.D. 1977. Performance of a new automatic carbon dioxide coulometer. *Microchem. J.* **22**: 567–573.
- Johnson, K.M., King, A.E. and Sieburth, J.M. 1985. Coulometric TCO<sub>2</sub> analyses for marine studies; an introduction. *Mar. Chem.* **16**: 61–82.
- Johnson, K.M., Williams, P.J. leB., Brändström, L. and Sieburth, J.M. 1987. Coulometric TCO<sub>2</sub> analysis for marine studies: automation and calibration. *Mar. Chem.* **21**: 117–133.
- Johnson, K.M., Wills, K.D., Butler, D.B., Johnson, W.K. and Wong, C.S. 1993. Coulometric total carbon dioxide analysis for marine studies: maximizing the performance of an automated continuous gas extraction system and coulometric detector. *Mar. Chem.* **44**: 167–187.
- UIC Inc. 1985. Instruction manual; model 5011 CO<sub>2</sub> coulometer.
- Wilke, R.J., Wallace, D.W.R. and Johnson, K.M. 1993. Water-based, gravimetric method for the determination of gas sample loop volume. *Anal. Chem.* **65**: 2403–2406.

## Annexe

Figure 1 illustrates the correct way to plumb an 8-port valve (e.g., W type valves from Valco Instruments Co. Inc., P.O. Box 55803, Houston, TX 77255, U.S.A.) to provide two gas loops where the volume of the valve rotor channels is not part of the loop volume. It is taken from Valco Instruments Co. Inc. Product Bulletin 101 “GC Applications for in-line rotary valves” (1992).

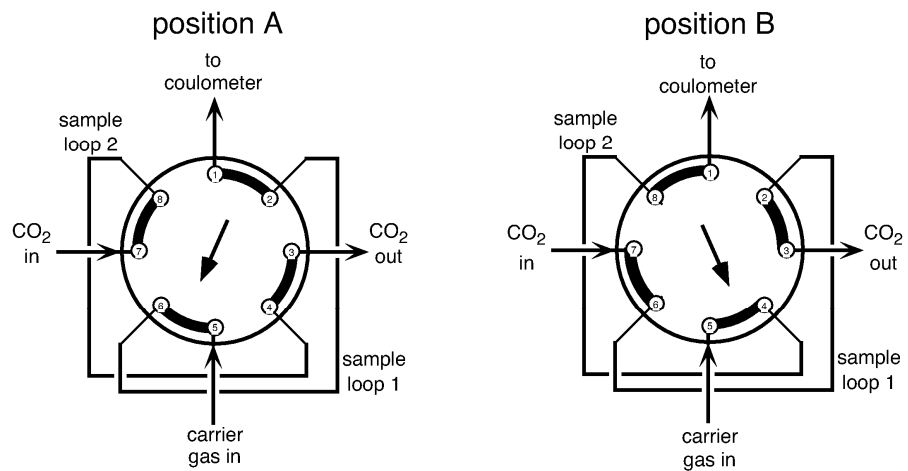

**Fig. 1** Plumbing of a gas loop calibration valve.

# SOP 3a

## Determination of total alkalinity in sea water using a closed-cell titration

### 1. Scope and field of application

This SOP describes an automated, closed-cell, potentiometric titration procedure used to determine total alkalinity in sea water. The results are expressed as moles per kilogram of sea water. The method is suitable for the assay of oceanic levels of total alkalinity (2000–2500  $\mu\text{mol kg}^{-1}$ ) and can be adapted easily to measure higher levels such as those that have been observed in the Black Sea (3200–4600  $\mu\text{mol kg}^{-1}$ ).

### 2. Definition

The total alkalinity of a sample of sea water is defined as the number of moles of hydrogen ion equivalent to the excess of proton acceptors (bases formed from weak acids with a dissociation constant  $K \leq 10^{-4.5}$  at 25°C and zero ionic strength) over proton donors (acids with  $K > 10^{-4.5}$ ) in 1 kilogram of sample:

$$\begin{aligned}
 A_T = & [\text{HCO}_3^-] + 2[\text{CO}_3^{2-}] + [\text{B}(\text{OH})_4^-] + [\text{OH}^-] + [\text{HPO}_4^{2-}] \\
 & + 2[\text{PO}_4^{3-}] + [\text{SiO}(\text{OH})_3^-] + [\text{NH}_3] + [\text{HS}^-] + \dots \\
 & - [\text{H}^+]_F - [\text{HSO}_4^-] - [\text{HF}] - [\text{H}_3\text{PO}_4] - \dots
 \end{aligned} \quad (1)$$

Brackets represent total concentrations of these constituents in solution,  $[\text{H}^+]_F$  is the free concentration of hydrogen ion (see Chapter 2) and the ellipses stand for additional minor acid or base species that are either unidentified or present in such small amounts that they can be safely neglected. The concentrations of  $\text{NH}_3$  and  $\text{HS}^-$  are typically so low that they can be neglected in open ocean water; they may, however, be significant in anoxic environments.

### 3. Principle

A known amount of sea water is placed in a closed cell where it is titrated with a solution of hydrochloric acid. The acid is made up in a sodium chloride background to approximate the ionic strength of sea water so as to maintain activity coefficients approximately constant during the titration. The use of a closed cell allows the subsequent data evaluation to assume that the total dissolved inorganic carbon remains constant throughout the titration—apart from the effect of dilution.

The progress of the titration is monitored using a glass electrode/reference electrode pH cell. Total alkalinity is computed from the titrant volume and e.m.f. data using either a least-squares procedure based on a non-linear curve fitting approach (see Annexe 1) or on a modified Gran approach<sup>1</sup>. Both total alkalinity and total dissolved inorganic carbon are computed from such titration data; however, the more direct extraction/coulometric method detailed in SOP 2 provides a more accurate procedure for the determination of total dissolved inorganic carbon<sup>2</sup>.

## 4. Apparatus

### 4.1 Titration cell assembly

A closed, thermostated, titration cell with an internal volume of 100 cm<sup>3</sup> or more is suitable. (Such a cell can be constructed from Lucite<sup>®</sup> incorporating an outer water jacket—see Figure 1.)

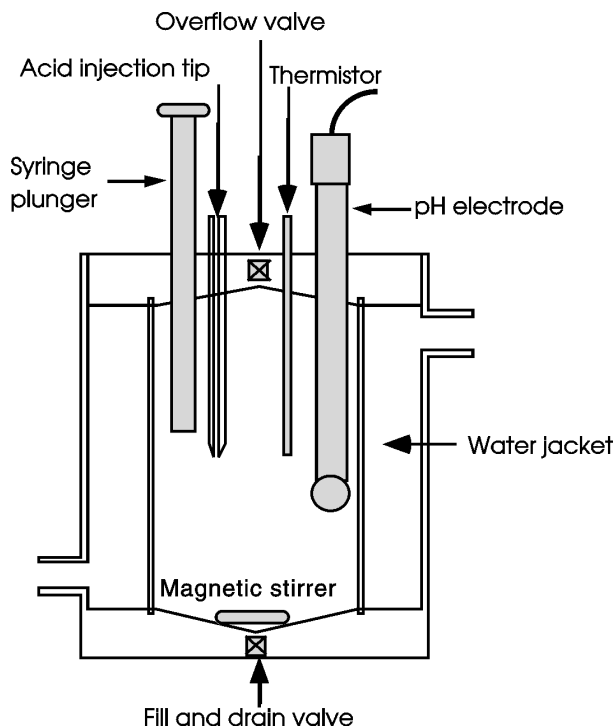

**Fig. 1** Closed titration cell for the determination of alkalinity.

<sup>1</sup> For more detail of the modified Gran approach, see Hansson and Jagner (1973) or Bradshaw *et al.* (1981).

<sup>2</sup> Typically,  $C_T$  is underestimated by a potentiometric titration, either because of omitting acid-base species, such as phosphate (see Bradshaw *et al.*, 1981), or because the actual Nernst factor for the electrode pair used is less than the theoretical value that is assumed to apply (see Millero *et al.*, 1993).

There is an optimal relationship between the size of the titration cell, the size of the piston burette and the strength of the acid used:

$$\frac{V(\text{burette})}{V(\text{cell})} \times C(\text{HCl}) = 3.5 \times 10^{-3} \text{ mol kg}^{-1}. \quad (2)$$

This equation is based on the assumption that a solution with a total alkalinity of  $2.5 \times 10^{-3} \text{ mol kg}^{-1}$  is titrated using a complete burette of acid to a final pH of 3, *i.e.*,  $[\text{H}^+] = 1.0 \times 10^{-3} \text{ mol kg}^{-1}$ .

This cell contains a combined glass/reference pH electrode<sup>3</sup>, a thermometer, a capillary tube that supplies acid from the burette and a plunger which is free to move, thus adjusting the volume of the cell as acid is added and allowing the titration to be carried out without a headspace. (The size of the plunger must therefore be matched to the size of the burette used.) A magnetic stirrer is used to stir the solution during the titration. It is desirable to know the internal volume,  $V_0$ , of this cell accurately (with the plunger fully depressed). Ideally,  $V_0$  should be measured using the technique outlined in SOP 13. However, an alternative calibration procedure, outlined in section 8.5, can be used if this is not possible.

## 4.2 pH meter

A pH meter or a high input impedance digital voltmeter<sup>4</sup>—readable to at least 0.1 mV—is connected to the pH cell and also interfaced to the computer which controls the titration.

## 4.3 Piston burette

A calibrated (see Annexe 2) motor-driven piston burette—reproducible to  $0.001 \text{ cm}^3$  in the delivered volumes—is interfaced to the computer which controls the titration. The appropriate burette size depends on the cell size and on the concentration of acid used; see section 4.1 equation (2).

## 4.4 Thermostat bath

A thermostat bath capable of maintaining the cell at a known temperature to within  $\pm 0.05^\circ\text{C}$ . This ensures that the  $E^\circ$  of the pH cell and the Nernst factor do not vary significantly during the titration.

## 5. Reagents

- Reagent grade hydrochloric acid,
- Reagent grade sodium chloride,

---

<sup>3</sup> Using a separate glass electrode/reference electrode pair can often improve the stability of the e.m.f. readings obtained.

<sup>4</sup> An external circuit based on a high input impedance operational amplifier (*e.g.*, an FET electrometer amplifier) configured as a voltage follower (unity gain amplifier) can be used to achieve this.

- Primary standard grade sodium carbonate, dried at 280°C for > 2 hours and cooled overnight in a desiccator<sup>5</sup>,
- Deionized water.

## 6. Sampling

Samples should be collected, poisoned and stored in accordance with the procedures detailed in SOP 1.

## 7. Procedure

### 7.1 Solution preparation

*Titrant* — A solution of hydrochloric acid containing enough sodium chloride to adjust the total ionic strength to approximate that of sea water (0.7 mol kg<sup>-1</sup>). (The HCl concentration is chosen to match the size of the burette and of the cell; see equation (2).)

*Background medium* — A solution of sodium chloride (0.7 mol kg<sup>-1</sup>).

*Calibration solutions*<sup>6,7</sup> — Three solutions<sup>8</sup> of sodium carbonate in the background medium (~ 0.5, 1.0 and 1.25 mmol kg<sup>-1</sup>) made up carefully by weight, *i.e.*, total alkalinities of ~ 1000, 2000 and 2500  $\mu\text{mol kg}^{-1}$ .

### 7.2 Titration procedure

**7.2.1** Bring the solution to be titrated to the approximate temperature that the titration will be carried out at before filling the cell. It is often convenient to place the sample bottle in the thermostat bath for a time to ensure this.

**7.2.2** Rinse the titration cell thoroughly with sea water<sup>9</sup> and then with the solution to be analyzed (background medium, or calibration solution). Fill the cell with the solution to be analyzed, overflowing the cell by a few cm<sup>3</sup>; finally, close the cell ensuring that the piston is in its “down” position and that no air bubbles are present.

---

<sup>5</sup> A method for preparing suitable Na<sub>2</sub>CO<sub>3</sub> is detailed in IUPAC (1969).

<sup>6</sup> The procedure here assumes that the acid is calibrated against weighed amounts of a solid acidimetric standard. Of course, a simpler approach is to use a certified sea water reference material (see Footnote 19) as a source of a solution of known alkalinity. However, doing so limits the ability to use the reference material as an independent quality control sample.

<sup>7</sup> An alternate solid that is well suited as an acidimetric standard is TRIS (2-amino-2-hydroxy-1,3-propanediol). It is available for this purpose from the U.S. National Institute for Standards and Technology (NIST). In many ways, TRIS is more convenient to use than sodium carbonate: it has a higher formula weight per mole of alkalinity and is easier to weigh. However, a different approach is needed to treat the resulting data (*e.g.*, a Gran treatment of data from past the equivalence point).

<sup>8</sup> A single calibration solution (~ 1.25 mmol kg<sup>-1</sup>) can be used. However, using a series of solutions will improve the estimate of the “blank” attributable to the NaCl background and thus the estimate of  $C(\text{HCl})$ —section 8.4.

<sup>9</sup> This is to rinse the acid out, thus any sea water is suitable for this and it is unnecessary to use a valuable sample.



- 7.2.3 Add the acid solution in about 20–30 small increments (0.1–0.2 cm<sup>3</sup>) into the cell from the burette<sup>10</sup>. After each acid addition, record the total volume of acid added and the e.m.f. of the pH cell—using the computer to check that the e.m.f. is stable<sup>11</sup>.
- 7.2.4 Once sufficient acid has been added to the sample to reach a pH of about 3, the titration is ended and the resulting data are used to compute the total alkalinity of the sample.

## 8. Calculation and expression of results

### 8.1 Introduction

There are two alternate approaches to estimating total alkalinity and total dissolved inorganic carbon from titration data: the use of a non-linear least-squares approach (see Annexe 1) or the use of modified Gran functions (where the equations are rearranged to a linear form and then fitted iteratively by the method of least-squares). Both approaches are based on the same mass-balance and equilibrium relationships; they differ only in how the experimental data are weighted in the least-squares fitting.

### 8.2 Derivation of basic equations

The defining equation for total alkalinity (1) is used to define a proton condition corresponding to the equivalence point:

$$\begin{aligned}
 [\text{H}^+]_{\text{F}} + [\text{HSO}_4^-] + [\text{HF}] + [\text{H}_3\text{PO}_4] \\
 = [\text{HCO}_3^-] + 2[\text{CO}_3^{2-}] + [\text{B}(\text{OH})_4^-] + [\text{OH}^-] + [\text{HPO}_4^{2-}] \\
 + 2[\text{PO}_4^{3-}] + [\text{SiO}(\text{OH})_3^-] + [\text{NH}_3] + [\text{HS}^-]. \quad (3)
 \end{aligned}$$

(Note that the existence of minor unidentified species has been ignored in this expression.) At any point in the titration, the analytical total concentration of hydrogen ion (relative to this proton condition) is given by the expression

$$\begin{aligned}
 C_{\text{H}} = [\text{H}^+]_{\text{F}} + [\text{HSO}_4^-] + [\text{HF}] + [\text{H}_3\text{PO}_4] - [\text{HCO}_3^-] \\
 - 2[\text{CO}_3^{2-}] - [\text{B}(\text{OH})_4^-] - [\text{OH}^-] - [\text{HPO}_4^{2-}] \\
 - 2[\text{PO}_4^{3-}] - [\text{SiO}(\text{OH})_3^-] - [\text{NH}_3] - [\text{HS}^-]. \quad (4)
 \end{aligned}$$

The initial analytical concentration of hydrogen ion in the solution is thus the negative of the total alkalinity. At any point in the titration, after a mass  $m$  of acid with concentration  $C$  (mol kg-soln<sup>-1</sup>) has been added to a mass  $m_0$  of sample<sup>12</sup>,

<sup>10</sup> Some investigators prefer to add acid so as to ensure approximately equal e.m.f. changes between titration points.

<sup>11</sup> The hydrated CO<sub>2</sub> formed in the vicinity of the burette tip takes a finite time to dehydrate again. With proper stirring it is the rate of this reaction that controls the overall time to reach a stable reading, rather than the mixing.

<sup>12</sup> Strictly, only masses are additive in the manner described here; however, to a good approximation, volumes can be used in these various expressions provided that they are used together with equilibrium constants expressed on a volumetric basis.

$$C_H = \frac{mC - m_0A_T}{m_0 + m}. \quad (5)$$

This can be equated to the previous expression for  $C_H$ :

$$\begin{aligned} \frac{mC - m_0A_T}{m_0 + m} = & [\text{H}^+]_F + [\text{HSO}_4^-] + [\text{HF}] + [\text{H}_3\text{PO}_4] - [\text{HCO}_3^-] \\ & - 2[\text{CO}_3^{2-}] - [\text{B}(\text{OH})_4^-] - [\text{OH}^-] - [\text{HPO}_4^{2-}] \\ & - 2[\text{PO}_4^{3-}] - [\text{SiO}(\text{OH})_3^-] - [\text{NH}_3] - [\text{HS}^-]. \end{aligned} \quad (6)$$

This equation is the basis of all computations involved in this procedure, although for titrations in NaCl media most of the terms will be equal to zero. Equation (6) is used together with the ideal Nernst equation<sup>13</sup>

$$E = E^\circ - (RT/F) \ln[\text{H}^+] \quad (7)$$

that relates the e.m.f. of the pH cell to the total concentration of hydrogen ion (*i.e.*, including the effect of sulfate ion) and together with relationships that express the individual species concentrations in terms of the total concentrations and the appropriate equilibrium constants (see Annexe 1 Table 1).

A computer program for computing the total alkalinity of a sea water sample—or of a sample containing only sodium carbonate in a sodium chloride background—from titration data is presented in Annexe 1 to this procedure. This program uses a non-linear least-squares approach and has been provided to show in detail how the calculations outlined above can be implemented.

### 8.3 Determination of the “blank” in the background medium

This “blank” reflects the presence of small quantities of alkaline impurities in the NaCl solution used to fortify the sodium carbonate standards. In treating such titration data, the total concentrations of sulfate, fluoride, phosphate, borate, silicate, *etc.* are set to zero and it is assumed that the alkalinity “blank” is due solely to carbonate species<sup>14</sup>. Also, it is essential, both in this section and in the next, to use equilibrium constants and densities that are appropriate to the background NaCl medium.

Data from a titration of the background medium alone (*i.e.*, NaCl without  $\text{Na}_2\text{CO}_3$ ) can be used to calculate the total alkalinity of the background medium. However, it is better to combine this result with the results from titrations of different levels of  $\text{Na}_2\text{CO}_3$  in the background medium (see next section).

<sup>13</sup> A number of investigators make further use of the titration curve from the blank determination (see section 8.3) to confirm that the electrode pair has a Nernst response ( $RT/F$ ). However, the value of the slope and the value of  $E^\circ$  obtained by fitting experimental results in this fashion are highly correlated and thus not particularly reliable. It is usually better to verify the response of the electrode pair used with suitable buffers (SOP 6). If the response is not theoretical within the experimental uncertainty, the electrodes should be rejected.

<sup>14</sup> This is not strictly true as the residual alkalinity cannot be removed completely by acidifying and stripping with a  $\text{CO}_2$ -free gas. Nevertheless, the error from assuming this is small.

## 8.4 Calibration of the acid titrant<sup>6,15</sup>

The total alkalinity of each calibration solution titrated (including a background solution with no added Na<sub>2</sub>CO<sub>3</sub>) is given by the sum

$$A_T = A_T(\text{blank}) + \frac{2m(\text{Na}_2\text{CO}_3)}{105.988} \times \frac{1}{m(\text{Na}_2\text{CO}_3 - \text{soln})} \quad (8)$$

where  $A_T(\text{blank})$  is the total alkalinity of the NaCl background solution,  $m(\text{Na}_2\text{CO}_3)$  the mass of Na<sub>2</sub>CO<sub>3</sub> used to prepare the solution and  $m(\text{Na}_2\text{CO}_3\text{-soln})$  the total mass of solution prepared (there are two moles of alkalinity per mole of sodium carbonate).

The measured values of  $A_T$  (calculated by assuming an approximate value for the acid concentration,  $C$ ) should be a linear function of the alkalinity component contributed by the Na<sub>2</sub>CO<sub>3</sub>—the second term in equation (8). This line is fitted by the method of least squares (SOP 23). The slope should be unity; the intercept should be the alkalinity of the NaCl background medium. If the measured slope ( $a$ ) is not equal to one, the acid concentration should be adjusted:

$$C_{i+1} = C_i / a \quad (9)$$

and the whole set of calculations repeated until  $a = 1$ .

## 8.5 Recalibration of the cell volume

Maintenance of the titration cell may require replacing the electrode(s), magnetic stirrer bar or plunger. As a result, the volume of the cell can change and will need to be measured again. Ideally, this is done gravimetrically (see SOP 13); however, when this is not practical (*e.g.*, at sea) it is computed using the following assumptions:

- the volume of the cell,  $V_0$ , is known approximately,
- the concentration of the acid is known accurately,
- the total alkalinity of a calibration solution is known accurately.

The following strategy is adopted. The cell is filled with a calibration solution of known total alkalinity and this is titrated with the calibrated acid. The e.m.f. and volume data are then used to compute a new value of  $V_0$  as follows: first assume an approximate value of the volume  $V_0'$ ; the computed total alkalinity is then related to the “true” volume,  $V_0$ , and to the “true” total alkalinity,  $A_T$ , by the expression

$$V_0 \approx V_0' A' / A_T \quad (10)$$

This calculation is iterated to obtain a consistent set of values<sup>16</sup>. It is desirable to repeat this measurement at least four times and to use the mean value in subsequent computations. This will reduce the uncertainty associated with  $V_0$ .

<sup>15</sup> It is necessary to exclude e.m.f. data measured at pHs higher than 8 so as to minimize the errors due to sodium ion at the glass electrode.

<sup>16</sup> Although this approach will not determine the physical volume of the cell as accurately as can be achieved gravimetrically, it does have the advantage of absorbing errors both in the concentration of the acid and in the burette calibration.

## 8.6 Treatment of sea water data

Once the volume of the cell ( $V_0$ ) and the concentration of the acid titrant ( $C$ ) are known, volume and e.m.f. data from a titration of a sea water sample can be used to compute both the total alkalinity and an estimate of the total dissolved inorganic carbon in the sample<sup>17</sup>. It is necessary to know the approximate salinity ( $\pm 0.1$ ) of the sea water sample so as to compute both its density and the appropriate equilibrium constants for use in the data treatment (see Annexe 1 to this procedure).

## 8.7 Example calculation

An example of a complete titration curve of sea water and calculated values for the various parameters are given together with the computer code in Annexe 1 to this procedure.

For the most accurate work, a further minor correction needs to be made to compute the total alkalinity in the original sea water sample for the dilution by mercuric chloride when the sample was collected<sup>18</sup>:

$$A_T = 1.0002 \times A_T' \quad (11)$$

## 9. Quality assurance

### 9.1 For general principles of analytical quality control see Chapter 3

### 9.2 Specific applications of analytical quality control

The various control limits outlined below are necessary to ensure that the accuracy and precision of the data are adequate for the purposes of a world-wide CO<sub>2</sub> survey. The initial targets specified for this are: a within cruise precision (1 SD) of 3  $\mu\text{mol kg}^{-1}$  and an overall between cruise (and between laboratory) range of bias of less than 6  $\mu\text{mol kg}^{-1}$ .

#### 9.2.1 Quality of individual titrations

For each titration, the quality can be assessed by examining the values of the residuals,  $\Delta_i$ , and of the “goodness of fit”:

$$s = \left( \sum_i \frac{\Delta_i^2}{m-n} \right)^{1/2} \quad (12)$$

where  $m$  is the total number of titration points and  $n$  is the number of parameters fitted ( $n = 4$ ; see Annexe 1);  $s$  is typically around 2  $\mu\text{mol kg}^{-1}$  for the program used here.

<sup>17</sup> This is not the best way to determine  $C_T$ . Far preferable is the use of a direct approach such as that detailed in SOP 2. Nevertheless, if the model of sea water acid–base chemistry is correct and if the pH cell behavior is Nernstian, both estimates should agree with each other.

<sup>18</sup> The value 1.0002 assumes that saturated mercuric chloride was used (0.02 % by volume—see SOP 1). If a 50% saturated solution was used to preserve the sample, the appropriate correction factor is 1.0004.

### 9.2.2 Stability of computed volume and/or titrant concentration

The mean value should remain stable to within 0.1% throughout a cruise (except if the cell configuration is changed, thus changing its volume). Plot the volumes and/or acid concentrations obtained on a property control chart (see SOP 22).

### 9.2.3 Analysis of a sea water reference material

A stable reference material<sup>19</sup> should be analyzed regularly. Plot the results obtained on a property control chart (see SOP 22).

### 9.2.4 Duplicate analyses

A duplicate analysis should be made on every tenth sample. Plot the difference between each pair of analyses on a range control chart (see SOP 22).

## 10. Bibliography

- Almgren T., Dyrssen, D. and Fonselius, S. 1983. Determination of alkalinity and total carbonate. pp. 99–123. *In: Methods of Seawater Analysis. Edited by K. Grasshoff, M. Ehrhardt and K. Kremling, Verlag Chemie, Weinheim.*
- Bos, D. and Williams, R.T. 1982. History and development of the GEOSECS alkalinity titration system. U.S. Department of Energy, CONF-7911173.
- Bradshaw, A.L., Brewer, P.G., Shafer, D.K. and Williams, R.T. 1981. Measurements of total carbon dioxide and alkalinity by potentiometric titration in the GEOSECS program. *Earth Planet. Sci. Lett.* **55**: 99–115.
- Brewer, P.G., Bradshaw, A.L., and Williams, R.T. 1986. Measurements of total carbon dioxide and alkalinity in the North Atlantic Ocean in 1981. *In: The Changing Carbon Cycle. A Global Analysis, pp. 348–370. Edited by J.R. Trabalka and D.E. Reiche, Springer-Verlag, New York.*
- Dickson, A.G. 1981. An exact definition of total alkalinity and a procedure for the estimation of alkalinity and total inorganic carbon from titration data. *Deep-Sea Res.* **28A**: 609–623.
- Dickson, A.G., Afghan, J.D. and Anderson, G.C. 2003. Reference materials for oceanic CO<sub>2</sub> analysis: a method for the certification of total alkalinity. *Mar. Chem.* **80**: 185–197.
- Hansson, I. and Jagner, D. 1973. Evaluation of the accuracy of Gran plots by means of computer calculations. Application to the potentiometric titration of the total alkalinity and carbonate content of sea water. *Anal. Chim. Acta* **65**: 363–372.
- IUPAC 1969. Sodium carbonate and sulphamic acid as acid-base primary standards. *Pure Appl. Chem.* **18**: 445–455.
- Johansson, O. and Wedborg, M. 1982. On the evaluation of potentiometric titrations of seawater with hydrochloric acid. *Oceanol. Acta* **5**: 209–218.
- Jones, F.E. and Harris, G.L. 1992. ITS-90 density of water formulation for volumetric standards calibration. *J. Res. Natl. Inst. Stand. Technol.* **97**: 335–340.
- Millero, F.J., Zhang, J.-Z., Lee, K. and Campbell, D.M. 1993. Titration alkalinity of seawater. *Mar. Chem.* **44**: 153–165.

---

<sup>19</sup> Available from Dr. Andrew G. Dickson, Marine Physical Laboratory, Scripps Institution of Oceanography, University of California, San Diego, 9500 Gilman Drive, La Jolla, CA 92093-0244, U.S.A. (fax: 1-858-822-2919; e-mail: co2crms@ucsd.edu).

## Annexe 1

### A non-linear least squares procedure for evaluating $A_T$ from titration data

In the following pages a computer program is presented which allows the computation of total alkalinity from titration data for a closed-cell titration of sea water. This program is based on a non-linear least-squares evaluation of the data similar to that used by Dickson (1981) and by Johansson and Wedborg (1982). The assumption is made in defining the model that the errors on the e.m.f. measurements are negligible in comparison to the uncertainties in the titrant amounts.

The computer program is based on equations (6) and (7) and requires that the salinity of the sea water sample and the total concentrations of species such as phosphate, silicate, *etc.* are known before evaluating the titration data<sup>20</sup>. If the titration is being performed on a solution in  $0.7 \text{ mol kg}^{-1}$  NaCl, then the program will select the appropriate dissociation constants and set the total concentrations of species such as sulfate, fluoride, phosphate, silicate, *etc.* to zero. Note, this code does not contain expressions for incorporating ammonia and hydrogen sulfide; for open ocean use the total concentrations of these are essentially equal to zero.

Instead of adjusting  $E^\circ$  directly in the least-squares procedure, it is convenient to define a multiplier,

$$f = [\text{H}^+]/[\text{H}'] \quad (13)$$

where values of  $[\text{H}']$  are computed from an initial estimate of  $E^\circ$  ( $E^\circ$ ):

$$[\text{H}'] = \exp\left(\frac{E^\circ - E}{RT/F}\right). \quad (14)$$

The program then adjusts  $f$  to minimize the sum-of-squares rather than adjusting the value of  $E^\circ$  directly.

Equation (6) is rewritten as

---

<sup>20</sup> This is rarely the case for the immediate evaluation of shipboard titrations of sea water samples; however, if sample salinity is known to within 0.1 and if species such as phosphate, silicate, *etc.* are neglected—assumed to have a zero concentration—the value of total alkalinity obtained will not be affected substantially. Nevertheless, the other adjusted parameters, such as  $C_T$  and  $K_1$ , will be in error and the quality of fit (sum-of-squares) will be degraded.

$$\begin{aligned}
& A_T - C_T \left( \frac{K_1 f [\text{H}'] + 2K_1 K_2}{(f [\text{H}'])^2 + K_1 f [\text{H}'] + K_1 K_2} \right) - B_T \left( \frac{1}{1 + (f [\text{H}'])/K_B} \right) \\
& - P_T \left( \frac{K_{1P} K_{2P} f [\text{H}'] + 2K_{1P} K_{2P} K_{3P} - (f [\text{H}'])^3}{(f [\text{H}'])^3 + K_{1P} (f [\text{H}'])^2 + K_{1P} K_{2P} (f [\text{H}']) + K_{1P} K_{2P} K_{3P}} \right) \\
& - Si_T \left( \frac{1}{1 + (f [\text{H}'])/K_{Si}} \right) - NH3_T \left( \frac{1}{1 + (f [\text{H}'])/K_{NH3}} \right) \\
& - H2S_T \left( \frac{1}{1 + (f [\text{H}'])/K_{H2S}} \right) + S_T \left( \frac{1}{1 + K_S Z / (f [\text{H}'])} \right) \\
& + F_T \left( \frac{1}{1 + K_F / (f [\text{H}'])} \right) + \left( \frac{m_0 + m}{m_0} \right) \left( \frac{f [\text{H}']}{Z} - \frac{K_w}{f [\text{H}']} \right) - \frac{m}{m_0} C = 0. \quad (15)
\end{aligned}$$

The various terms are defined in Table 1; correspondence with the terms in equation (6) can be seen in Table 2.

Note in equation (15) how the free hydrogen ion concentration is calculated directly from the total hydrogen ion concentration when needed by using the expression

$$[\text{H}^+]_F = [\text{H}^+] / Z \quad (16)$$

where  $Z$  is defined in Table 1. This allows the direct use of equilibrium constants defined on the total scale in the various computations and renders the calculation substantially independent of likely errors in  $K_S$ .

Note also that the amounts of titrant ( $m$ ) and of titrand ( $m_0$ ) are expressed as masses rather than volumes. Volumes are converted to masses using a knowledge of the densities of these solutions appropriate to the temperature of the titration.

The actual data fitting is performed using a general non-linear least-squares routine. Equation (15) is used to define a vector of residuals (*i.e.*, the extent to which the left hand side  $\neq 0$ ) that are calculated in the subroutine FCN; the MINPACK-1 software package<sup>21</sup> minimizes the sum-of-squares of these residuals by adjusting the four parameters:  $f$ ,  $A_T$ ,  $C_T$ , and  $K_1$ . LIMDIFI uses a Marquardt procedure for this calculation, and computes the Jacobian by a finite-difference approximation. Any similar non-linear least-squares fitting package could be used in place of MINPACK, requiring only minor alterations to the code.

<sup>21</sup> Moré, J.J., Garbow, B.S. and Hillstom, K.E. 1980. User guide for MINPACK-1. Report ANL-80-74 of the Argonne National Laboratory, Argonne, IL, U.S.A.

**Table 1** Equations for the sea water acid–base system.**Mass-conservation equations**

$$C_T = [\text{CO}_2^*] + [\text{HCO}_3^-] + [\text{CO}_3^{2-}] \quad (17)$$

$$B_T = [\text{B}(\text{OH})_3] + [\text{B}(\text{OH})_4^-] \quad (18)$$

$$S_T = [\text{HSO}_4^-] + [\text{SO}_4^{2-}] \quad (19)$$

$$F_T = [\text{HF}] + [\text{F}^-] \quad (20)$$

$$P_T = [\text{H}_3\text{PO}_4] + [\text{H}_2\text{PO}_4^-] + [\text{HPO}_4^{2-}] + [\text{PO}_4^{3-}] \quad (21)$$

$$Si_T = [\text{Si}(\text{OH})_4] + [\text{SiO}(\text{OH})_3^-] \quad (22)$$

$$NH_{3T} = [\text{NH}_4^+] + [\text{NH}_3] \quad (23)$$

$$H_2S_T = [\text{H}_2\text{S}] + [\text{HS}^-] \quad (24)$$

**Equilibrium constants<sup>22</sup>**

$$K_1 = [\text{H}^+][\text{HCO}_3^-]/[\text{CO}_2^*] \quad (25)$$

$$K_2 = [\text{H}^+][\text{CO}_3^{2-}]/[\text{HCO}_3^-] \quad (26)$$

$$K_B = [\text{H}^+][\text{B}(\text{OH})_4^-]/[\text{B}(\text{OH})_3] \quad (27)$$

$$K_W = [\text{H}^+][\text{OH}^-] \quad (28)$$

$$K_S = [\text{H}^+]_F[\text{SO}_4^{2-}]/[\text{HSO}_4^-] \quad (29)$$

$$K_F = [\text{H}^+][\text{F}^-]/[\text{HF}] \quad (30)$$

$$K_{1P} = [\text{H}^+][\text{H}_2\text{PO}_4^-]/[\text{H}_3\text{PO}_4] \quad (31)$$

$$K_{2P} = [\text{H}^+][\text{HPO}_4^{2-}]/[\text{H}_2\text{PO}_4^-] \quad (32)$$

$$K_{3P} = [\text{H}^+][\text{PO}_4^{3-}]/[\text{HPO}_4^{2-}] \quad (33)$$

$$K_{Si} = [\text{H}^+][\text{SiO}(\text{OH})_3^-]/[\text{Si}(\text{OH})_4] \quad (34)$$

$$K_{\text{NH}_3} = [\text{H}^+][\text{NH}_3]/[\text{NH}_4^+] \quad (35)$$

$$K_{\text{H}_2\text{S}} = [\text{H}^+][\text{HS}^-]/[\text{H}_2\text{S}] \quad (36)$$

**Additional definitions**

$$Z = 1 + S_T / K_S \quad (37)$$

<sup>22</sup> All these equilibrium constants—except  $K_S$  (which is on the free hydrogen ion scale)—are based on the total hydrogen ion pH scale, *i.e.*, incorporating the effect of sulfate (but not of fluoride).



**Table 2** Expression for the concentrations of the various species in equation (6).

$$[\text{HCO}_3^-] = \frac{C_T K_1 [\text{H}^+]}{[\text{H}^+]^2 + K_1 [\text{H}^+] + K_1 K_2} \quad (38)$$

$$[\text{CO}_3^{2-}] = \frac{C_T K_1 K_2}{[\text{H}^+]^2 + K_1 [\text{H}^+] + K_1 K_2} \quad (39)$$

$$[\text{B(OH)}_4^-] = B_T / (1 + [\text{H}^+] / K_B) \quad (40)$$

$$[\text{OH}^-] = K_w / [\text{H}^+] \quad (41)$$

$$[\text{H}_3\text{PO}_4] = \frac{P_T [\text{H}^+]^3}{[\text{H}^+]^3 + K_{1P} [\text{H}^+]^2 + K_{1P} K_{2P} [\text{H}^+] + K_{1P} K_{2P} K_{3P}} \quad (42)$$

$$[\text{H}_2\text{PO}_4^-] = \frac{P_T K_{1P} [\text{H}^+]^2}{[\text{H}^+]^3 + K_{1P} [\text{H}^+]^2 + K_{1P} K_{2P} [\text{H}^+] + K_{1P} K_{2P} K_{3P}} \quad (43)$$

$$[\text{HPO}_4^{2-}] = \frac{P_T K_{1P} K_{2P} [\text{H}^+]}{[\text{H}^+]^3 + K_{1P} [\text{H}^+]^2 + K_{1P} K_{2P} [\text{H}^+] + K_{1P} K_{2P} K_{3P}} \quad (44)$$

$$[\text{PO}_4^{3-}] = \frac{P_T K_{1P} K_{2P} K_{3P}}{[\text{H}^+]^3 + K_{1P} [\text{H}^+]^2 + K_{1P} K_{2P} [\text{H}^+] + K_{1P} K_{2P} K_{3P}} \quad (45)$$

$$[\text{SiO(OH)}_3^-] = S_{iT} / (1 + [\text{H}^+] / K_{Si}) \quad (46)$$

$$[\text{NH}_3] = NH_{3T} / (1 + [\text{H}^+] / K_{\text{NH}_3}) \quad (47)$$

$$[\text{HS}^-] = H_2S_T / (1 + [\text{H}^+] / K_{\text{H}_2\text{S}}) \quad (48)$$

$$[\text{H}^+]_F = [\text{H}^+] / (1 + S_T / K_S) \quad (49)$$

$$[\text{HSO}_4^-] = S_T / (1 + K_S / [\text{H}^+]_F) \quad (50)$$

$$[\text{HF}] = F_T / (1 + K_F / [\text{H}^+]) \quad (51)$$

A FORTRAN 77 program is available to do these calculations. It has the following structure.

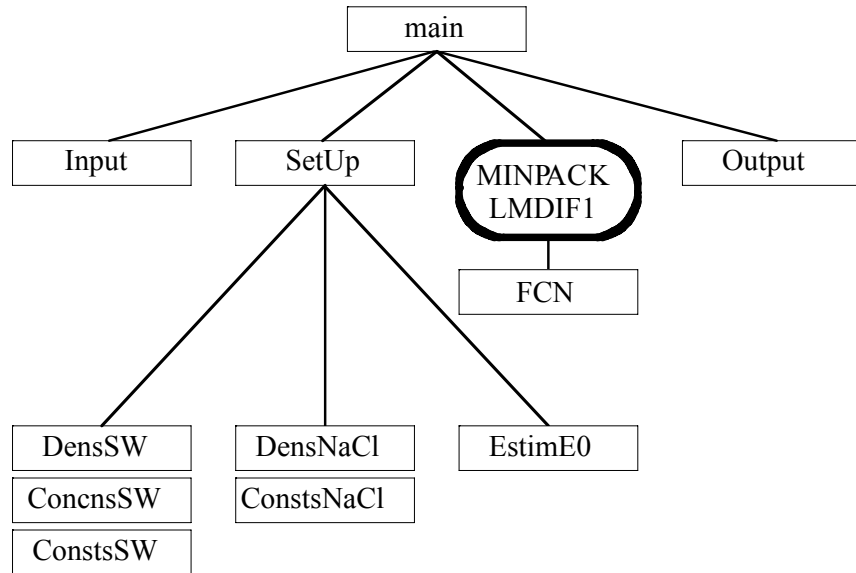

The source code is available from:

Dr. Andrew G. Dickson  
Marine Physical Laboratory – 0244  
University of California, San Diego  
9500 Gilman Drive  
La Jolla, CA 92093-0244, U.S.A.  
Fax: 1-858-822-2919  
E-mail: [adickson@ucsd.edu](mailto:adickson@ucsd.edu)

## Annexe 2

### Dosimat<sup>®</sup> burette calibration procedure

#### 1. Scope and field of application

The goal of this procedure is to calibrate a Metrohm Dosimat<sup>®</sup> burette accurately so that it can be used in the open-cell, alkalinity titration procedure (see procedure).

#### 2. Principle

The burette is filled with deionized water whose temperature is equilibrated to that of the surrounding room and measured accurately. Aliquots of the water are dispensed into pre-weighed vials that are capped and re-weighed. The true volumes dispensed are then calculated from a knowledge of the density of the deionized water and a “calibration function” is prepared for the burette under consideration.

#### 3. Apparatus

- Metrohm Dosimat<sup>®</sup> burette base unit,
- Metrohm Dosimat<sup>®</sup> exchangeable burette (5 cm<sup>3</sup> capacity),
- 15 × 5 cm<sup>3</sup> capacity screw-capped glass bottles<sup>23</sup>,
- Analytical balance readable to 0.0001 g,
- Calibrated thermometer readable to 0.1°C,
- Waste container.

#### 4. Reagents

- Deionized water (Milli-Q<sup>®</sup> quality).

#### 5. Procedure

- 5.1 Fill the Dosimat<sup>®</sup> reservoir with deionized water and allow to equilibrate to room temperature.

---

<sup>23</sup> Although glass containers are superior, excellent results can be obtained with plastic containers provided that appropriate anti-static precautions are taken when weighing.

- 5.2 Assemble the Dosimat<sup>®</sup> as usual except remove the anti-diffusion portion of the dispensing tip.
- 5.3 Submerge the thermometer in a reservoir bottle.
- 5.4 Fill and empty the Dosimat<sup>®</sup> burette several times; check to be sure that there are no bubbles in the burette and delivery tubing.
- 5.5 Weigh a dry, screw-capped glass bottle.
- 5.6 Dispense the water in the burette into a waste container. Make sure that the delivery tip is below the surface of the water. After dispensing, slowly withdraw the tip from the water.
- 5.7 Record the temperature as burette refills.
- 5.8 Dispense between 0.05 and 5.00 cm<sup>3</sup> of water into a weighed glass bottle<sup>24</sup>. Ensure that the delivery tip is immersed in dispensed solution.
- 5.9 Withdraw the tip slowly, cap the bottle and reweigh.
- 5.10 Repeat, varying the amount of water dispensed; repeat the measurement at least twice for each volume dispensed.

## 6. Calculation and expression of results

### 6.1 Principle

Compute the weight of the water delivered from the difference between the filled and empty container volumes:

$$w(\text{H}_2\text{O}) = w(\text{filled container}) - w(\text{empty container}). \quad (52)$$

Compute the mass of water contained, correcting for air buoyancy (see SOP 21):

$$m(\text{H}_2\text{O}) = w(\text{H}_2\text{O}) \left[ 1 + 0.0012 \left( \frac{1}{\rho(\text{H}_2\text{O}, t)} - \frac{1}{\rho(\text{weights})} \right) \right]. \quad (53)$$

The volume dispensed at the temperature noted ( $t$ ) is

$$V(t) = m(\text{H}_2\text{O}) / \rho(\text{H}_2\text{O}, t). \quad (54)$$

The density of air-saturated water in the temperature range 5 to 40°C is given by the expression (Jones and Harris, 1992)

$$\begin{aligned} \rho_w / (\text{kg m}^{-3}) = & 999.84847 + 6.337563 \times 10^{-2} (t / ^\circ\text{C}) \\ & - 8.523829 \times 10^{-3} (t / ^\circ\text{C})^2 + 6.943248 \times 10^{-5} (t / ^\circ\text{C})^3 \\ & - 3.821216 \times 10^{-7} (t / ^\circ\text{C})^4 \end{aligned} \quad (55)$$

where  $t$  is the temperature on ITS 90<sup>25</sup>. To achieve an accuracy of 1 part in 10<sup>4</sup>,  $t$  must be known to within 0.5°C.

<sup>24</sup> This procedure is designed to provide a series of calibration points corresponding to dispensing from 0.000 cm<sup>3</sup> on the burette.

<sup>25</sup> The distinction between the temperature scales ITS90 and IPTS68 is not important for this procedure.

The volumes measured are then compared to the nominal volumes indicated by the burette display so as to develop a “calibration function” for the particular burette system being calibrated.

## 6.2 Sample calculation

The following table contains a set of calibration results for a Metrohm Dosimat<sup>®</sup> system used in our laboratory.

**Table 1** Calibration results for titration system 1 (December 12, 1996).

Nominal volume, $V^* / \text{cm}^3$	Dispensing temperature, $t / ^\circ\text{C}$	Weight dispensed, $w / \text{g}$	Volume dispensed, $V / \text{cm}^3$	Volume correction, $\Delta V / \text{cm}^3$
1.000	20.9	0.9971	1.0001	0.0001
1.000	20.9	0.9957	0.9987	-0.0013
1.000	20.9	0.9971	1.0001	0.0001
2.000	20.9	1.9936	1.9997	-0.0003
2.000	20.9	1.9937	1.9998	-0.0002
3.000	20.9	2.9906	2.9997	-0.0003
3.000	21.0	2.9915	3.0007	0.0007
3.000	21.1	2.9912	3.0004	0.0004
4.000	21.1	3.9865	3.9988	-0.0012
4.000	21.1	3.9877	4.0000	0.0000
4.000	21.1	3.9877	4.0000	0.0000
4.000	21.2	3.9872	3.9996	-0.0004
5.000	21.2	4.9833	4.9988	-0.0012
5.000	21.3	4.9834	4.9990	-0.0010
3.050	21.3	3.0400	3.0495	-0.0005
0.050	21.3	0.0511	0.0513	0.0013
0.050	21.4	0.0499	0.0501	0.0001

The measured values of  $\Delta V$  obtained are plotted against the nominal volume (see Figure 2), *and* are fitted to provide a “calibration” function—typically a polynomial in  $V(\text{nominal})$ :

$$V = V^* [1 + aV^* + b(V^*)^2]. \quad (56)$$

For the measurements given in Table 1, and shown in Figure 2, the calibration function is not significantly different from

$$V = V^*, \quad (57)$$

which is the function that is used for this burette. The volume uncertainty at any point in this calibration is  $\pm 0.0007 \text{ cm}^3$  (r.m.s. deviation).

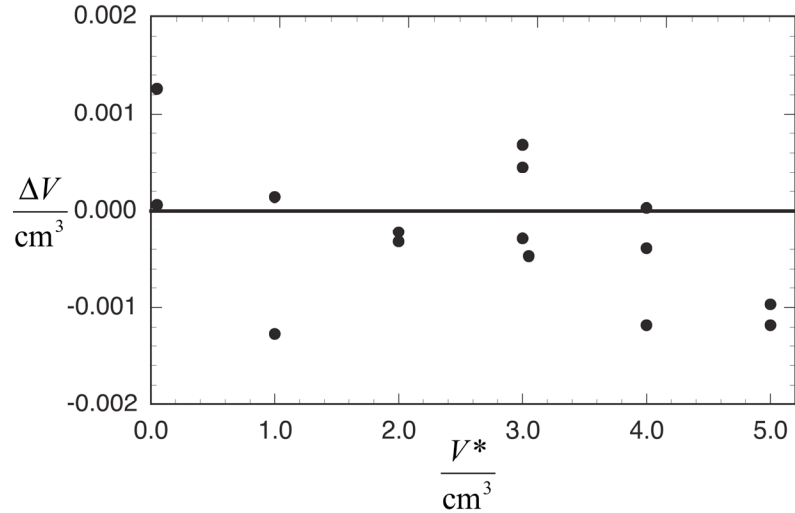

**Fig. 2** Plot of  $\Delta V (= V - V^*)$  against  $V^*$  for the calibration results for titration system 1 (December 12, 1996).

## 7. Quality Assurance

It is essential to identify a complete burette system as a coherent unit for the purpose of calibration and subsequent use. If it is necessary to change any of the parts (particularly the burette assembly or the base unit), it is essential to recalibrate the burette.

A new burette system should be calibrated a number of times initially to ensure that the calibration is stable. After that, it should be recalibrated yearly (or if a possible problem is identified).

# SOP 3b

## Determination of total alkalinity in sea water using an open-cell titration

### 1. Scope

In this method, an open-cell, potentiometric titration procedure used to determine total alkalinity in sea water is described. The results are expressed as moles per kilogram of sea water. The method is suitable for assaying oceanic levels of total alkalinity (2000–2500  $\mu\text{mol kg}^{-1}$ ). Lower values may be encountered in coastal and surface polar waters. This method should be suitable for the lower range with a smaller initial acid addition.

### 2. Terms and definitions

The total alkalinity of a sea water sample is defined as the number of moles of hydrogen ion equivalent to the excess of proton acceptors (bases formed from weak acids with a dissociation constant  $K \leq 10^{-4.5}$  at 25°C and zero ionic strength) over proton donors (acids with  $K > 10^{-4.5}$ ) in 1 kilogram of sample:

$$\begin{aligned} A_T = & [\text{HCO}_3^-] + 2[\text{CO}_3^{2-}] + [\text{B}(\text{OH})_4^-] + [\text{OH}^-] + [\text{HPO}_4^{2-}] \\ & + 2[\text{PO}_4^{3-}] + [\text{SiO}(\text{OH})_3^-] + [\text{NH}_3] + [\text{HS}^-] + \dots \\ & - [\text{H}^+]_F - [\text{HSO}_4^-] - [\text{HF}] - [\text{H}_3\text{PO}_4] - \dots \end{aligned} \quad (1)$$

Brackets represent total concentrations of these constituents in solution,  $[\text{H}^+]_F$  is the free concentration of hydrogen ion, and the ellipses represent additional minor acid or base species that are either unidentified or present in such small amounts that they can be ignored. The concentrations of ammonia and hydrogen sulfide are typically so low that they can be neglected when studying open ocean water; they may, however, be significant in anoxic environments.

### 3. Principle

A known amount of sea water is placed in an open cell where it is titrated with a solution of hydrochloric acid in a two-stage titration. The sample of sea water is first acidified to a pH between 3.5 and 4.0 with a single aliquot of titrant. The solution is then stirred for a period of time to allow for the escape of  $\text{CO}_2$  that has evolved. The titration is continued until a pH of about 3.0 has been reached.

The acid is made up in a sodium chloride background to approximate the ionic strength of sea water so as to maintain approximately constant activity coefficients during the titration. The use of an open cell allows one to assume, in subsequent data processing, that the total dissolved inorganic carbon (and so the amount of residual bicarbonate ion) is approximately zero in the pH region of 3.0 to 3.5. The progress of the titration is monitored using a pH glass electrode/reference electrode cell, and the total alkalinity is computed from the titrant volume and e.m.f. measurements using a non-linear least-squares approach that corrects for the reactions with sulfate and fluoride ions.

## 4. Apparatus

### 4.1 Measurement of sample size

- Calibrated balance to weigh<sup>1</sup> 200 g to within 0.01 g,
- 125 cm<sup>3</sup> plastic screw-cap bottle with cap.

### 4.2 Titration cell assembly

- 250 cm<sup>3</sup> capacity jacketed beaker with 2¼ inch (~ 6 cm) internal diameter;
- Calibrated thermometer readable to 0.01°C. This is used to confirm that the solution temperature remains constant during the titration and to provide the value of solution temperature for use in subsequent calculations;
- Thermostat bath capable of maintaining temperature to better than ± 0.05°C;
- Magnetic stirrer with a 1½ inch × 5/16 inch (~ 4 cm × 0.8 cm) stir bar;
- Holder for burette tip, electrode, and thermometer.

### 4.3 E.M.F. measuring assembly

- Digital voltmeter readable to 0.00001 V;
- High-impedance voltage follower amplifier system. The system is used to buffer the e.m.f. of the combination pH glass electrode/reference electrode cell so that it can be measured accurately using a digital voltmeter<sup>2</sup>;
- Combination pH glass electrode/reference electrode cell<sup>3,4</sup>.

---

<sup>1</sup> Because weighing on a balance can not be done aboard ship, volume-based methods can be used as a substitute, *e.g.*, a properly calibrated (see SOP 12), water-jacketed pipette.

<sup>2</sup> A custom made amplifier, based on an operational amplifier obtained from Burr-Brown (#9323), is satisfactory. A digital pH meter (± 0.1 mV) can be used instead of a digital voltmeter and voltage-follower amplifier, but there will be inferior measurement precision.

<sup>3</sup> The performance of the pH electrode is paramount for achieving high-quality results. The performance of a new electrode can be assessed by measuring  $A_T$  on a sea water reference material. If the certified value is not obtained, it may even be necessary to replace a new electrode.

<sup>4</sup> Radiometer Model PHC2402 (#945-505), together with a Type 7 to BNC adaptor (Radiometer #617-801), permits connection to a voltage-follower amplifier.



#### 4.4 Burette assembly

- Metrohm Dosimat<sup>®</sup> Model 665 burette base with keypad;
- Metrohm Dosimat<sup>®</sup> 5 cm<sup>3</sup> burette exchange unit;
- Metrohm Dosimat<sup>®</sup> anti-diffusion tip;
- Calibrated digital thermometer readable to 0.1°C (used to measure acid temperature).

A highly reproducible burette ( $\pm 0.001$  cm<sup>3</sup>) is necessary to obtain the highest quality results. Unfortunately, although the burette specified is capable of the high reproducibility needed, its accuracy is typically not as good, and the burette system must be calibrated prior to use.

#### 4.5 Air flow to purge carbon dioxide

- A pump whose flow rate can be controlled to provide *ca.* 100 ml min<sup>-1</sup>;
- A flowmeter to indicate gas flow rate (*ca.* 100 ml min<sup>-1</sup>);
- Tubing leading to a bubbler in the cell.

#### 4.6 Miscellaneous

##### 4.6.1 Sample transfer device

This device was designed to allow a sample to be dispensed from a bottle with a greased, ground-glass joint in a manner that ensures that grease is not transferred to the weighing bottle. The system we use comprises a rubber stopper (#8–9) through which two rigid plastic tubes are skewered; the rubber stopper is secured to the sample bottle with a metal clamp. One of the tubes is long enough to make contact with the bottom of a 500 cm<sup>3</sup> sample bottle, and the other tube protrudes about ¼ inch ( $\sim 0.6$  cm) below the stopper. The shorter tube is attached with about 20 inches ( $\sim 50$  cm) of Tygon<sup>®</sup> tubing to a rubber bulb, which is used to pressurize the system. The other tube is attached to a length of Tygon<sup>®</sup> tubing (*ca.* 18 inches ( $\sim 45$  cm)) and is closed with a pinch clamp. This tube is used to dispense the sample.

##### 4.6.2 Basin for waste

### 5. Reagents/Supplies

- Calibrated titrant solution of concentration approximately 0.1 mol kg<sup>-1</sup> in hydrochloric acid and 0.6 mol kg<sup>-1</sup> in sodium chloride<sup>5</sup>,
- Wash bottle containing Milli-Q<sup>®</sup> deionized water,
- Kimwipes<sup>®</sup>.

---

<sup>5</sup> The hydrochloric acid titrant solution is calibrated with an accuracy of better than  $\pm 0.02\%$  using a coulometric titration procedure. In addition, the density of this titrant solution must be known as a function of temperature with an accuracy of better than  $\pm 0.02\%$ .

## 6. Procedure

### 6.1 Apparatus set-up

Assemble the apparatus as shown in Figure 1.

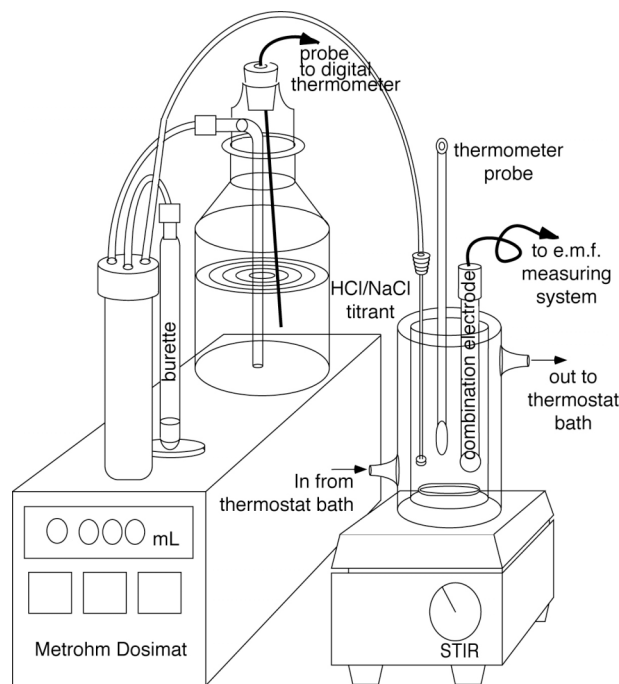

**Fig. 1** Open-cell alkalinity measurement set-up.

**6.1.1** Assemble the apparatus as shown in the diagram above. Use extra caution assembling the Dosimat<sup>®</sup> glass pieces and tubing. Make all connections finger tight, and do not over-tighten. The most common cause of leaks and bubbles is damaged threads and chipped glass.

**6.1.2** Set the thermostat bath to 25°C.

**6.1.3** Mix the hydrochloric acid titrant solution to ensure a consistent temperature and composition.

**6.1.4** Ensure that the Dosimat<sup>®</sup> burette and tubing are thoroughly flushed with the titrant solution and that no air bubbles are present.

### 6.2 Titration set-up<sup>6</sup>

**6.2.1** Thoroughly mix the contents of the sample bottle. Remove the stopper, and use a Kimwipe<sup>®</sup> to remove as much grease as possible. Dry the

<sup>6</sup> If the system has not been used for some hours, it may be necessary to condition the pH glass-reference electrode system. Simply use it for one or more titrations where the result(s) will be discarded. (This first measurement is often a little lower than the correct value.)

longer tube of the sample transfer device (section 4.6); insert it into the sample bottle, securing it with the metal clamp. Pressurize the bottle, and flush the tubing with about 20 cm<sup>3</sup> of sample (discard to waste).

- 6.2.2 Fill a 125 cm<sup>3</sup> plastic bottle with sample, cap tightly, and weigh; record the weight to 0.01 g.
- 6.2.3 Carefully pour the sample into the clean 250 cm<sup>3</sup> jacketed beaker containing a 1½ inch (~ 4 cm) stir bar.
- 6.2.4 Recap the plastic bottle, and record the empty weight. The sample weight is obtained by difference in the two.
- 6.2.5 Begin stirring.
- 6.2.6 Position the holder assembly over the beaker so the four parts are well into the sample without interfering with the stir bar.

### 6.3 Titration procedure

- 6.3.1 With slow stirring, dispense enough hydrochloric acid to bring the sample to a pH just above 3.5 (~ 3 cm<sup>3</sup>).<sup>7</sup>
- 6.3.2 Increase the stirring rate until it is vigorous but not splashing. Turn on air flow through the solution.
- 6.3.3 Leave the acidified sample stirring for at least 6 minutes to allow for CO<sub>2</sub> degassing.
- 6.3.4 Titrate the sample using 0.05 cm<sup>3</sup> increments to a final pH of *ca.* 3.0 (~ 20 increments). After each addition, record the total dispensed volume to 0.001 cm<sup>3</sup>, the e.m.f. to 0.00001 V and the sample temperature to 0.01°C.

### 6.4 Cleanup after each titration

- 6.4.1 Once the titration is complete, remove the holder assembly from the beaker, and position it over the waste basin.
- 6.4.2 Purge the remaining acid in the burette (from the previous titration) into the waste basin, and refill the burette<sup>8</sup>. (To prevent bubbles from forming in the burette and tubing, vent the acid bottle during each filling of the burette.)
- 6.4.3 Record the hydrochloric acid solution temperature to 0.1°C.
- 6.4.4 Rinse the acid tip, electrode, and thermometer thoroughly with water from the wash bottle. Gently touch-dry with Kimwipes®.

---

<sup>7</sup> The amount of acid added will depend on the approximate alkalinity of the sample. Typically, this is known well enough to allow estimation of the initial acid addition.

<sup>8</sup> Purging the burette is a precautionary measure that is not universally used. It is intended to prevent contamination of the acid in the burette tip.

**6.4.5** Pour the spent sample into the waste basin. Use the wash bottle to rinse the beaker and stir bar three times. Thoroughly dry the beaker and stir bar with Kimwipes<sup>®</sup>, and return the stir bar to the beaker.

## **6.5 Cleanup for system storage**

If the apparatus will be left out overnight, leave the burette tip, thermometer, and electrode in the last solution titrated. If no more samples will be run for 2 days or longer, clean up the apparatus in the following manner:

- 6.5.1** Cover the clean, dry beaker and stir bar to protect them from dust.
- 6.5.2** Disconnect the acid bottle, and seal it with a lightly greased, ground glass stopper<sup>9</sup>.
- 6.5.3** Use Milli-Q<sup>®</sup> water to thoroughly rinse the glass piece from the acid bottle and the thermometers, then set it out to dry in a place protected from dust.
- 6.5.4** Refill the burette with air.
- 6.5.5** Remove the burette and plunger, and thoroughly rinse with Milli-Q<sup>®</sup> water.
- 6.5.6** Replace the burette, and dispense 5 cm<sup>3</sup> to purge any acid remaining in the tubing.
- 6.5.7** As the burette refills, submerge the flexible tubing end (goes to the acid bottle) in a beaker of Milli-Q<sup>®</sup> water so that the burette is filled with Milli-Q<sup>®</sup> water.
- 6.5.8** Again, dispense 5 cm<sup>3</sup> and fill the burette with Milli-Q<sup>®</sup> water to flush out all the acid.
- 6.5.9** Finally, refill the burette with air, and purge the tubing of all remaining liquid.
- 6.5.10** Disconnect the burette, and set it to dry protected from dust.
- 6.5.11** Rinse the outside of the acid tip, and place it in the test tube holder.
- 6.5.12** Cover the Dosimat<sup>®</sup> valve and all tubing with a plastic bag.
- 6.5.13** Rinse the electrode, cover the filling hole, and place it in a suitable storage solution in an airtight container.
- 6.5.14** Turn off all instruments.

---

<sup>9</sup> A screw cap with a Teflon<sup>®</sup> liner, as is provided with Dosimat<sup>®</sup> bottles, may also be used.

## 7. Calculation and expression of results

### 7.1 Introduction

The titration data can be processed using an Excel<sup>®</sup> spreadsheet program. Points from the pH region 3.0 to 3.5 are treated using an approach in which the equivalence point is determined using a non-linear least-squares fit of the results. To process sea water samples, the total dissolved inorganic carbon is assumed to be zero, and corrections are made for sulfuric acid and hydrogen fluoride formation.

### 7.2 Derivation of basic equations

The defining equation for total alkalinity is used to specify a proton condition corresponding to this equivalence point:

$$\begin{aligned} [\text{H}^+]_{\text{F}} + [\text{HSO}_4^-] + [\text{HF}] + [\text{H}_3\text{PO}_4] \\ = [\text{HCO}_3^-] + 2[\text{CO}_3^{2-}] + [\text{B}(\text{OH})_4^-] + [\text{OH}^-] + [\text{HPO}_4^{2-}] \\ + 2[\text{PO}_4^{3-}] + [\text{SiO}(\text{OH})_3^-] + [\text{NH}_3] + [\text{HS}^-]. \end{aligned} \quad (2)$$

(Note that the existence of minor, unidentified species has been ignored in this expression.) At each point in the titration, the analytical total concentration of hydrogen ion (relative to this proton condition) is given by

$$\begin{aligned} C_{\text{H}} = [\text{H}^+]_{\text{F}} + [\text{HSO}_4^-] + [\text{HF}] + [\text{H}_3\text{PO}_4] - [\text{HCO}_3^-] \\ - 2[\text{CO}_3^{2-}] - [\text{B}(\text{OH})_4^-] - [\text{OH}^-] - [\text{HPO}_4^{2-}] \\ - 2[\text{PO}_4^{3-}] - [\text{SiO}(\text{OH})_3^-] - [\text{NH}_3] - [\text{HS}^-]. \end{aligned} \quad (3)$$

The initial analytical concentration of hydrogen ion in the solution is thus the negative of the total alkalinity. After a mass  $m$  of acid<sup>10</sup> with concentration  $C$  (mol kg-soln<sup>-1</sup>) has been added to a mass  $m_0$  of sample,

$$C_{\text{H}} = \frac{-m_0 A_{\text{T}} + m C}{m_0 + m}. \quad (4)$$

This expression can be equated to the previous expression for  $C_{\text{H}}$ :

$$\begin{aligned} \frac{-m_0 A_{\text{T}} + m C}{m_0 + m} = [\text{H}^+]_{\text{F}} + [\text{HSO}_4^-] + [\text{HF}] + [\text{H}_3\text{PO}_4] - [\text{HCO}_3^-] \\ - 2[\text{CO}_3^{2-}] - [\text{B}(\text{OH})_4^-] - [\text{OH}^-] - [\text{HPO}_4^{2-}] \\ - 2[\text{PO}_4^{3-}] - [\text{SiO}(\text{OH})_3^-] - [\text{NH}_3] - [\text{HS}^-]. \end{aligned} \quad (5)$$

Equation (5) is the basis of the computations involved in this procedure; however, as only pH data in the range 3.0–3.5 are used, and as the CO<sub>2</sub> generated

<sup>10</sup> Typically, acid is added by volume, and its density is known accurately. In this procedure, the acid temperature is monitored carefully, and the appropriate density is estimated from laboratory measurements of the acid density as a function of temperature.

by the reaction with the acid titrant is lost to the atmosphere, the majority of these terms can be ignored (Dickson *et al.*, 2003). Hence, (5) can be reduced to

$$\frac{-m_0 A_T + mC}{m_0 + m} \approx [\text{H}^+]_F + [\text{HSO}_4^-] + [\text{HF}]. \quad (6)$$

### 7.3 Computational procedures<sup>11</sup>

Equation (6) is used to estimate  $A_T$  from titration data by means of a non-linear least-squares procedure. First, it is necessary to start with reasonable estimates for  $A_T$  and  $E^\circ$  so as to ensure convergence. A simple Gran approach is used for this. Equation (6) is approximated by

$$\frac{-m_0 A_T + mC}{m_0 + m} \approx [\text{H}^+] = \exp\left(\frac{E - E^\circ}{RT/F}\right) = k \exp\left(\frac{E}{RT/F}\right) \quad (7)$$

where  $[\text{H}^+]$  is the “total” hydrogen ion concentration defined as<sup>12</sup>

$$[\text{H}^+] = [\text{H}^+]_F (1 + S_T / K_S) \approx [\text{H}^+]_F + [\text{HSO}_4^-]. \quad (8)$$

In this expression,  $S_T$  is the total sulfate concentration, and  $K_S$  is the acid dissociation constant of  $[\text{HSO}_4^-]$ . Equation (7) is rearranged to give the Gran function

$$F_1 = (m_0 + m) \exp\left(\frac{E}{RT/F}\right). \quad (9)$$

This function is linear in  $m$  and has a zero at  $A_T = mC/m_0$  that can be estimated from a linear least-squares fit of  $F_1$  against  $m$ .

Once the  $A_T$  estimate has been obtained, (7) is rearranged to calculate an estimate of  $E^\circ$  at each titration point:

$$E^\circ = E - \left(\frac{RT}{F}\right) \ln\left(\frac{-m_0 A_T + mC}{m_0 + m}\right). \quad (10)$$

These values are averaged to obtain an initial estimate of  $E^\circ$ .

A non-linear least-squares calculation is then used to refine these values of  $A_T$  and  $E^\circ$ . However, rather than adjusting  $E^\circ$  directly, it is convenient to define a multiplier

$$f = [\text{H}^+] / [\text{H}'] \quad (11)$$

where estimates of  $[\text{H}^+]$  ( $[\text{H}']$ ) are computed from the initial estimate of  $E^\circ$ :

<sup>11</sup> The values used for  $R$  and  $F$ , the functions used for the acid dissociation constants,  $K_S$  and  $K_F$ , and the expressions for the total concentrations,  $S_T$  and  $F_T$ , are given in Chapters 2 and 5.

<sup>12</sup> A comparison of (7) and (8) with (6) shows that the term  $[\text{HF}]$  has been neglected for this initial stage of the calculation. It is, however, included in the non-linear least-squares evaluation.

$$[H'] = \exp\left(\frac{E - E^\circ}{RT / F}\right), \quad (12)$$

*i.e.*, the error in  $E^\circ$  (the difference between this initial estimate and the *true* value) appears as a multiplicative factor in the hydrogen ion concentration ( $f$ ) that can then be adjusted in the least-squares procedure (rather than adjusting the value of  $E^\circ$  directly).

Equation (6) is thus rewritten as

$$A_T + \left(\frac{S_T}{1 + K_S Z / (f [H'])}\right) + \left(\frac{F_T}{1 + K_F / (f [H'])}\right) + \left(\frac{m_0 + m}{m_0}\right) \left(\frac{f [H']}{Z}\right) - \left(\frac{m}{m_0}\right) C = 0 \quad (13)$$

where  $F_T$  is the total sulfate concentration, and  $K_F$  is the acid dissociation constant of [HF]. In this equation, the product,  $f [H']$ , represents the total hydrogen ion concentration and  $f [H'] / Z$  the free hydrogen ion concentration, where  $Z = (1 + S_T / K_S)$ , and thus

$$[H^+]_F = [H^+] / Z = [H^+] / (1 + S_T / K_S). \quad (14)$$

This approach (though seemingly cumbersome) renders the calculation essentially independent of likely errors in  $K_S$ .

The actual data fitting is performed using a non-linear least-squares routine. Equation (13) is used to define a vector of residuals (*i.e.*, the extent to which the left hand side differs from 0), and the software then minimizes the sum-of-squares of these residuals by adjusting the parameters,  $f$  and  $A_T$ . During this procedure, care is taken to ensure that the initial and final titration points of the data set processed are those for which the calculated pH lies the closest to the values 3.5 and 3.0, respectively. Points that lie outside this region are excluded from the calculation.

The choice of pH range is appropriate for the following reasons. If there is some bicarbonate present, it will be a negligible amount ( $< 0.5 \mu\text{mol kg}^{-1}$ ) even at the highest pH used (3.5) and will be still less at the lower pH. Furthermore, at pH lower than 3.0, the simple Nernst equation no longer holds true, as the liquid junction potential for a pH cell is a function of hydrogen ion concentration ( $\sim 30 \text{ mV/mol-H}^+ \text{ kg}^{-1}$ ); in addition, the effect of uncertainties in  $K_S$  becomes more problematic at low pHs.

## 7.4 Example calculation

An example of a complete set of titration data for a sea water sample, together with the resulting calculated values for  $A_T$  and  $E^\circ$ , is given.

### Sample information

Mass of sea water 140.32 g

Salinity 33.923

*Hydrochloric acid titrant information*

Concentration 0.10046 mol kg-soln<sup>-1</sup>  
Density 1.02393 g cm<sup>-3</sup>

*Titration temperature*

24.25°C



*Titration values*

$V / \text{cm}^{-3}$	$E / \text{V}$
3.500	0.18607
3.550	0.18893
3.600	0.19150
3.650	0.19384
3.700	0.19601
3.750	0.19800
3.800	0.19986
3.850	0.20159
3.900	0.20321
3.950	0.20473
4.000	0.20617
4.050	0.20753
4.100	0.20880
4.150	0.21002
4.200	0.21120
4.250	0.21233
4.300	0.21341
4.350	0.21446
4.400	0.21545
4.450	0.21641
4.500	0.21732
4.550	0.21820*

*Titration results*

$$A_T = 2260.06 \mu\text{mol kg-soln}^{-1}$$

$$E^\circ = 0.394401 \text{ V}$$

The point marked with an asterisk was excluded from the final processing as the calculated pH is outside the range 3.0–3.5.

For the most accurate work, a further minor correction may need to be made to compute the total alkalinity in the original sea water sample: for the dilution by mercuric chloride when the sample was collected<sup>13</sup>,

$$A_T = 1.0002 \times A_T' . \quad (15)$$

## 8. Quality assurance

For general principles of analytical quality control, see Chapter 3.

### 8.1 Target control limits

#### 8.1.1 Introduction

---

<sup>13</sup> The value 1.0002 assumes that saturated mercuric chloride was used (0.02% by volume—SOP 1. If a 50% saturated solution was used to preserve the sample, the appropriate correction factor is 1.0004.

The various control limits outlined below are necessary to ensure that the accuracy and precision of the results are adequate for the purpose of certifying reference materials. The targets specified to meet these requirements are a precision (1 SD) of better than  $1 \mu\text{mol kg}^{-1}$  and an overall bias of less than  $2 \mu\text{mol kg}^{-1}$ .

### 8.1.2 *Quality of individual titrations*

For each titration, quality can be assessed by examining the standard deviation of the final  $E^\circ$  value ( $s(E^\circ)$ ). This is typically less than 0.04 mV for the apparatus used here (*i.e.*, measuring  $E$  to within 0.01 mV).

### 8.1.3 *Analysis of a sea water reference material*

A certified reference material should be analyzed regularly<sup>14</sup>. Plot the results obtained on a property control chart (see SOP 22). Expect a standard deviation on the order of  $1 \mu\text{mol kg-soln}^{-1}$  or less<sup>15</sup>.

### 8.1.4 *Duplicate analyses*

A duplicate analysis should be made on each sample (including the certified reference material). Plot the difference between each pair of analyses on a range control chart (see SOP 22). Expect a standard deviation on the order of  $0.5 \mu\text{mol kg-soln}^{-1}$ .

## 8.2 Instrument calibration

Ensure that the calibrations of the various instruments used in this procedure are confirmed at least once a year, though the effects of sudden changes should show up on the control charts described above.

## 9. Bibliography

- Dickson, A.G. 1981. An exact definition of total alkalinity and a procedure for the estimation of alkalinity and total inorganic carbon from titration data. *Deep-Sea Res.* **28A**: 609–623.
- Dickson, A.G., Afghan, J.D. and Anderson, G.C. 2003. Reference materials for oceanic CO<sub>2</sub> analysis: a method for the certification of total alkalinity. *Mar. Chem.* **80**: 185–197.
- Gran, G. 1952. Determination of the equivalence point in potentiometric titrations. Part II. *Analyst* **77**: 661–670.
- Jones, F.E. and Harris, G.L. 1992. ITS-90 density of water formulation for volumetric standards calibration. *J. Res. Natl. Inst. Stand. Technol.* **97**: 335–340.

---

<sup>14</sup> Suitable reference materials are available from Dr. Andrew G. Dickson, Marine Physical Laboratory, Scripps Institution of Oceanography, University of California, San Diego, 9500 Gilman Drive, La Jolla, CA 92093-0244, U.S.A. (fax: 1-858-822-2919; e-mail: co2crms@ucsd.edu).

<sup>15</sup> If the analyses on a particular day are problematic, the electrode behavior is the usual suspect.

# Annexe

## Dosimat<sup>®</sup> burette calibration procedure

### 1. Scope and field of application

The goal of this procedure is to calibrate a Metrohm Dosimat<sup>®</sup> burette accurately so that it can be used in the open-cell, alkalinity titration procedure (see procedure).

### 2. Principle

The burette is filled with deionized water whose temperature is equilibrated to that of the surrounding room and measured accurately. Aliquots of the water are dispensed into pre-weighed vials that are capped and reweighed. The true volumes dispensed are then calculated from a knowledge of the density of the deionized water and a “calibration function” is prepared for the burette under consideration.

### 3. Apparatus

- Metrohm Dosimat<sup>®</sup> burette base unit,
- Metrohm Dosimat<sup>®</sup> exchangeable burette (5 cm<sup>3</sup> capacity),
- 15 × 5 cm<sup>3</sup> capacity screw-capped glass bottles<sup>16</sup>,
- Analytical balance readable to 0.0001 g,
- Calibrated thermometer readable to 0.1°C,
- Waste container.

### 4. Reagents

- Deionized water (Milli-Q<sup>®</sup> quality).

### 5. Procedure

- 5.1** Fill the Dosimat<sup>®</sup> reservoir with deionized water and allow to equilibrate to room temperature.

---

<sup>16</sup> Although glass containers are superior, excellent results can be obtained with plastic containers provided that appropriate anti-static precautions are taken when weighing.

- 5.2 Assemble the Dosimat<sup>®</sup> as usual except remove the anti-diffusion portion of the dispensing tip.
- 5.3 Submerge the thermometer in a reservoir bottle.
- 5.4 Fill and empty the Dosimat<sup>®</sup> burette several times; check to be sure that there are no bubbles in the burette and delivery tubing.
- 5.5 Weigh a dry, screw-capped glass bottle.
- 5.6 Dispense the water in the burette into a waste container. Make sure that the delivery tip is below the surface of the water. After dispensing, slowly withdraw the tip from the water.
- 5.7 Record the temperature as burette refills.
- 5.8 Dispense between 0.05 and 5.00 cm<sup>3</sup> of water into a weighed glass bottle<sup>17</sup>. Ensure that the delivery tip is immersed in dispensed solution.
- 5.9 Withdraw the tip slowly, cap the bottle and reweigh.
- 5.10 Repeat, varying the amount of water dispensed; repeat the measurement at least twice for each volume dispensed.

## 6. Calculation and expression of results

### 6.1 Principle

Compute the weight of the water delivered from the difference between the filled and empty container volumes:

$$w(\text{H}_2\text{O}) = w(\text{filled container}) - w(\text{empty container}). \quad (16)$$

Compute the mass of water contained, correcting for air buoyancy (see SOP 21):

$$m(\text{H}_2\text{O}) = w(\text{H}_2\text{O}) \left[ 1 + 0.0012 \left( \frac{1}{\rho(\text{H}_2\text{O}, t)} - \frac{1}{\rho(\text{weights})} \right) \right]. \quad (17)$$

The volume dispensed at the temperature noted ( $t$ ) is

$$V(t) = m(\text{H}_2\text{O}) / \rho(\text{H}_2\text{O}, t). \quad (18)$$

The density of air-saturated water in the temperature range 5 to 40°C is given by the expression (Jones and Harris, 1992)

$$\begin{aligned} \rho_w / (\text{kg m}^{-3}) = & 999.84847 + 6.337563 \times 10^{-2} (t / ^\circ\text{C}) \\ & - 8.523829 \times 10^{-3} (t / ^\circ\text{C})^2 + 6.943248 \times 10^{-5} (t / ^\circ\text{C})^3 \\ & - 3.821216 \times 10^{-7} (t / ^\circ\text{C})^4 \end{aligned} \quad (19)$$

where  $t$  is the temperature on ITS 90<sup>18</sup>. To achieve an accuracy of 1 part in 10<sup>4</sup>,  $t$  must be known to within 0.5°C.

<sup>17</sup> This procedure is designed to provide a series of calibration points corresponding to dispensing from 0.000 cm<sup>3</sup> on the burette.

<sup>18</sup> The distinction between the temperature scales ITS90 and IPTS68 is not important for this procedure.

The volumes measured are then compared to the nominal volumes indicated by the burette display so as to develop a “calibration function” for the particular burette system being calibrated.

## 6.2 Sample calculation

The following table contains a set of calibration results for a Metrohm Dosimat<sup>®</sup> system used in our laboratory.

**Table 1** Calibration results for titration system 1 (December 12, 1996).

Nominal volume, $V^* / \text{cm}^3$	Dispensing temperature, $t / ^\circ\text{C}$	Weight dispensed, $w / \text{g}$	Volume dispensed, $V / \text{cm}^3$	Volume correction, $\Delta V / \text{cm}^3$
1.000	20.9	0.9971	1.0001	0.0001
1.000	20.9	0.9957	0.9987	-0.0013
1.000	20.9	0.9971	1.0001	0.0001
2.000	20.9	1.9936	1.9997	-0.0003
2.000	20.9	1.9937	1.9998	-0.0002
3.000	20.9	2.9906	2.9997	-0.0003
3.000	21.0	2.9915	3.0007	0.0007
3.000	21.1	2.9912	3.0004	0.0004
4.000	21.1	3.9865	3.9988	-0.0012
4.000	21.1	3.9877	4.0000	0.0000
4.000	21.1	3.9877	4.0000	0.0000
4.000	21.2	3.9872	3.9996	-0.0004
5.000	21.2	4.9833	4.9988	-0.0012
5.000	21.3	4.9834	4.9990	-0.0010
3.050	21.3	3.0400	3.0495	-0.0005
0.050	21.3	0.0511	0.0513	0.0013
0.050	21.4	0.0499	0.0501	0.0001

The measured values of  $\Delta V$  obtained are plotted against the nominal volume (see Figure 2), *and* are fitted to provide a “calibration” function—typically a polynomial in  $V(\text{nominal})$ :

$$V = V^* [1 + aV^* + b(V^*)^2]. \quad (20)$$

For the measurements given in Table 1, and shown in Figure 2, the calibration function is not significantly different from

$$V = V^*, \quad (21)$$

which is the function that is used for this burette. The volume uncertainty at any point in this calibration is  $\pm 0.0007 \text{ cm}^3$  (r.m.s. deviation).

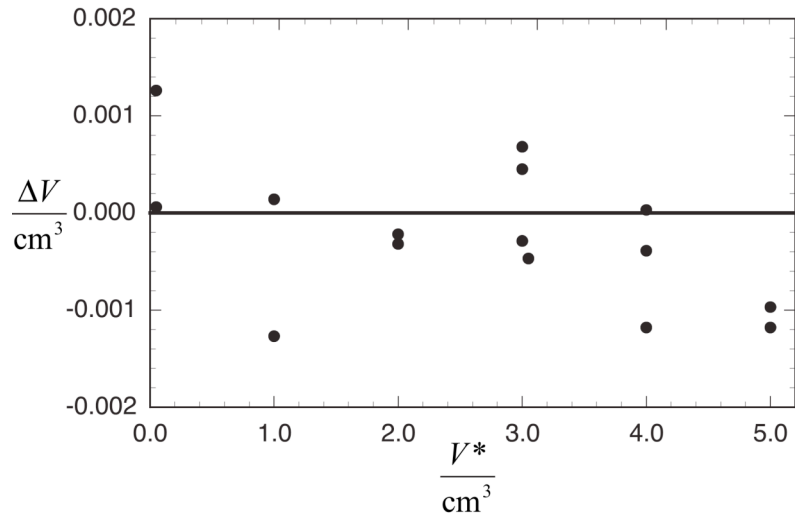

**Fig. 2** Plot of  $\Delta V = V - V^*$  against  $V^*$  for the calibration results for titration system 1 (December 12, 1996).

## 7. Quality Assurance

It is essential to identify a complete burette system as a coherent unit for the purpose of calibration and subsequent use. If it is necessary to change any of the parts (particularly the burette assembly or the base unit), it is essential to recalibrate the burette.

A new burette system should be calibrated a number of times initially to ensure that the calibration is stable. After that, it should be recalibrated yearly (or if a possible problem is identified).

# SOP 4

## Determination of $p(\text{CO}_2)$ in air that is in equilibrium with a discrete sample of sea water

### 1. Scope and field of application

This procedure describes a method for the determination of the partial pressure of carbon dioxide in air that is in equilibrium with a discrete sample of sea water. The partial pressure of carbon dioxide is expressed in microatmospheres. The method determines the dry mole fraction of air in equilibrium with oceanic water samples (250–2000  $\mu\text{atm}$  at 20°C).

### 2. Definition

The partial pressure of carbon dioxide in air that is in equilibrium with a sample of sea water is defined as the product of the mole fraction of  $\text{CO}_2$  in the equilibrated gas phase and the total pressure of equilibration:

$$p(\text{CO}_2) = x(\text{CO}_2) \cdot p. \quad (1)$$

The partial pressure of  $\text{CO}_2$  is a temperature-dependent property of the sea water sample; thus it is important to record the temperature at equilibrium.

### 3. Principle

A known amount of sea water is isolated in a closed system containing a small known volume of air (containing a known initial amount of carbon dioxide) and maintained at a constant, known temperature and pressure. Once the water and air are in equilibrium<sup>1</sup> a sample of the air is analyzed for carbon dioxide content using a gas chromatograph or infrared  $\text{CO}_2$  detector which is capable of integrating a constant volume of  $\text{CO}_2$ .<sup>2</sup> The partial pressure,  $p(\text{CO}_2)$ , is calculated from (1).

---

<sup>1</sup> Typically the gas and liquid phases are mixed thoroughly to speed this process up. The approach commonly used is to recirculate the air through a frit immersed in the sea water sample. The circulation of small air bubbles through the volume of water acts to not only equilibrate the water, but also stir it. The frit should be close to the surface.

<sup>2</sup> A non-dispersive infrared detector can also be used to quantify the amount of  $\text{CO}_2$  and can be used to assess the rate of approach to equilibrium (see *e.g.*, Wanninkhof and Thoning, 1993). However, such a detector requires a larger air/water ratio—and thus

## 4. Apparatus<sup>3</sup>

### 4.1 Gas analyzer system

There are several ways to measure equilibrated headspace gas. This procedure focuses on the measurement of a constant volume of headspace gas which, once equilibrated with the sample water, is carried with  $\text{CO}_2$ -free gas (for flame ionization detection the carrier gas will need to be hydrocarbon free  $\text{N}_2$ ).

#### 4.1.1 *Gas analyzer that is capable of accurately integrating the total amount of $\text{CO}_2$ in a sample loop*

For best results using a gas chromatographic technique, the following are recommended:

- A 2.0 m chromatographic column and 0.2 m precolumn packed with porous polystyrene (60–80 mesh) (Chromosorb 102 or Porapak Q);
- A catalytic system to convert carbon dioxide to methane (Ruthenium on Chromosorb W support);
- A flame-ionization detector for methane quantification.

#### 4.1.2 *Computer-controlled 10-port 2-position valve with two 1 cm<sup>3</sup> sample loops for sample injection and column switching*

This 10-port, 2-position valve should be contained in a temperature controlled box so that loops with known volume can be carefully temperature controlled and monitored. In this configuration one loop will always have the carrier gas flowing through it while the other loop will be in line with a selected sample equilibrator. Before the valve is switched, the flow of sample headspace gas must stop to allow the sample to be pressure and temperature equilibrated with the temperature controlled system.

#### 4.1.3 *Analog to digital integrator*

Unless one can ensure that there is a predictable relationship between  $\text{CO}_2$  concentration and the peak height of  $\text{CO}_2$  passing through the analyzer, it is important to integrate the full area under the curve to account for peak broadening and carrier gas flow rate changes.

### 4.2 $\text{CO}_2$ equilibration system

The ideal equilibration system will be contained in a single temperature controlled water bath in close proximity to the selection valve and  $\text{CO}_2$  gas analyzer to ensure minimal length of tubing in which the sample will be circulated. To avoid transferring samples from one container to another, each

---

involves a larger and less reliable correction for  $\text{CO}_2$  exchange (see section 8.2)—also infrared detectors are non-linear and thus require more elaborate calibration for use over such a wide range of  $\text{CO}_2$  concentrations. In addition, it is important to take account of the effect of  $\text{H}_2\text{O}$  vapor on the infrared performance of the instrument.

<sup>3</sup> The system described here is based on that used at the Lamont-Doherty Earth Observatory. A schematic diagram of that apparatus is provided in the Annexe to this procedure.



sample will be analyzed in the same sample container that it was collected. This can be done by recirculating headspace through a 0.5 L sample using a small air pump.

#### ***4.2.1 Constant-temperature bath***

Because the partial pressure of  $\text{CO}_2$  has a large sensitivity to changes in temperature, it is necessary to control the temperature and measure sample water temperature to less than 0.05 K at hourly time intervals. Because it may take up to an hour for the sample temperature to reach the bath temperature, and the air pumps used to circulate headspace air through the sample container are a source of heat, care must be taken to measure and record the sample temperature directly. Alternatively, with a good understanding of the temperature equilibration time of your system and the offset between bath temperature and sample temperature, given a typical air flow through the sample flask, corrections can be derived.

#### ***4.2.2 Air pumps for re-circulating headspace gas***

It is important that the air pump does not pump more than  $1.0 \text{ L min}^{-1}$  at full speed and that the pump speed can be controlled to reduce the amount of aerosols and heat that are circulated through the headspace plumbing.

#### ***4.2.3 Thermometer ( $\pm 0.02^\circ\text{C}$ )***

Accurate temperature measurements are essential and should be recorded continuously throughout the measurement period.

#### ***4.2.4 Borosilicate glass flask (0.5 L) with 0.10 m extensions or long-neck sampling flasks (e.g., volumetric flask)***

To provide adequate room for bubbles and froth from incoming air rising up through the sample, it is useful to have a long neck or extension on the sampling bottle. It should also be noted that the thinner walled flasks will equilibrate with the thermostat bath more quickly.

#### ***4.2.5 Three-hole stopper, nylon tubing and frit to carry headspace gas through equilibrators***

The equilibration is done in a closed loop by pushing air from the pump to just below the water level of each sample flask through a nylon tube and frit. Air passes out of the sample cell through a second nylon tube flush with the stopper. A third tube provides an opening to ensure that the samples are at ambient pressure. The longer the tube, the less likely it is that the headspace will be contaminated by room air. A net flow of gas into or out of the third opening is an indication of a leak in the system.

#### ***4.2.6 0.5 $\mu\text{m}$ syringe filters***

Filters are used to capture aerosols and water droplets on the downstream side of the equilibrator.

### 4.3 Calibration system

- Remotely operated valve allowing selection between the three calibration gases,
- Normally closed solenoid shut-off valve used to control the flow of calibration gas,
- Barometer, accurate to  $\pm 50$  Pa (0.5 mbar), with computer interface.

### 4.4 System control

- Microcomputer for data logging,
- Digital interface board to control valves, *etc.*

## 5. Reagents

### 5.1 Compressed gases

- Carrier gas: hydrocarbon-free nitrogen,
- FID gases: hydrocarbon-free hydrogen (*e.g.*, from a hydrogen generator) and air (*e.g.*, from a pure air generator),
- Three calibration gas mixtures of  $\text{CO}_2$  in air: well-known  $\text{CO}_2$  concentrations chosen to span the range of measured values:  $x(\text{CO}_2) = 250\text{--}2000 \times 10^{-6}$ .

## 6. Sampling

It is essential that samples are collected, poisoned and stored according to the procedure detailed in SOP 1. However, for this analysis the sample bottles are  $500 \text{ cm}^3$  volumetric flasks. Samples are equilibrated in the same bottles in which they are collected, eliminating one transfer operation.

## 7. Procedure

### 7.1 Introduction

This procedure has been designed to maximize the sample analysis while accounting for drifts in the system and allowing for both temperature and headspace equilibration of  $\text{CO}_2$  in each sample. The normal sequence of analysis accounts for changes in the response of the detector with time by running a set of standards (typically three) through the analyzer before and after a set of four samples has been run. To ensure full air–water equilibration of  $\text{CO}_2$  in headspace volumes of  $\sim 0.04$  L with 0.5 L of sea water with flow rates of  $\sim 0.2 \text{ L min}^{-1}$ , it is necessary to circulate the air for 8 minutes. In extreme conditions, it may take an hour to equilibrate sample temperatures to bath temperatures. To ensure temperature equilibration, samples should be stored near measurement temperatures, and the sample in the temperature-controlled bath replaced immediately after the previous sample has been analyzed.

## 7.2 System start-up

To begin a sample analysis run it is important to ensure that the system is stable. To save standards it is possible to run laboratory air samples as follows:

- 7.2.1 Disconnect the lines leading to and from the equilibrators, so that the pumps will fill the sample loop with ambient air rather than equilibrated air.
- 7.2.2 Run these analyses without the use of calibration gases, thus conserving the calibration gases (this can be achieved by using a separate subroutine in the operating program).

Calculation of  $p(\text{CO}_2)$  for a set of samples requires knowledge of the concentration of  $\text{CO}_2$  in the headspace gas prior to starting the equilibration. This is estimated—in part—from the  $p(\text{CO}_2)$  of the previous sample analysis. Thus, after reconnecting the lines to the equilibrators (see above), analyze two dummy (or practice) samples prior to running the main suite of analyses. Subsequently, the final samples from an analysis session can be left in place until the next set of analyses begins (see section 7.5).

## 7.3 Loading of new samples

As each sample analysis is completed (see section 7.4), replace the previous sample flask with a fresh sample as described below. The immediate replacement of a recently analyzed sample will ensure that the headspace has a known  $\text{CO}_2$  concentration at the start of the equilibration time period.

- 7.3.1 Bring the next sample to the equilibration temperature prior to analysis (*e.g.*, by placing it in the same thermostat bath used to maintain the analysis temperature). As mentioned above, it is important to pre-equilibrate the sample temperature to ensure that the sample is at the thermostat bath temperature when the headspace gas is analyzed.
- 7.3.2 Turn off the recirculation pump for the equilibrator. This minimizes the exchange of laboratory air with the air currently in the pump and tubing, and prevents sample water from being forced into the return line leading to the gas analyzer.
- 7.3.3 Open the drain valve for the equilibrator and insert the stopper with gas disperser, return line and drain line into the next sample flask (see diagram).
- 7.3.4 Force sample water out from the flask through the drain line using air of known  $\text{CO}_2$  concentration admitted to the flask through the return line.
- 7.3.5 Stop the flow of air once the water level reaches the bottom end of the drain tube and close the drain valve.
- 7.3.6 Turn the recirculation air pump back on.

## 7.4 Equilibration of sample

Full equilibration with the headspace can take as long as 8 minutes, depending on the total headspace and loop size. It is therefore necessary to ensure that air being captured in the sample gas loop has circulated for an adequate amount of time before capturing the sample and moving on to the next sample.

## 7.5 Acceptance criterion

Analyze each sample in duplicate (two consecutive equilibrations of the same water sample). Compare the integrated detector peak areas for the  $\text{CO}_2$  from the two analyses; if the difference between the two areas is less than 0.25% of the mean of the two areas, accept the results and replace the sample flask by a fresh sample, as described in section 7.3.

If the two analyses differ by more than this amount, do not replace the flask, but re-analyze it as part of the next sequence. After any sample has been analyzed a third and fourth time, it is replaced whether or not it has attained the acceptance criterion.

Repeated failure of samples to attain this criterion on a particular equilibrator suggests that it is necessary to clean the system, as aerosol particles of salt or water may be restricting the air flows or interfering with the action of the recirculation pump.

## 7.6 Termination of analytical session

Following the analysis of the final samples of a given session (including the final set of calibration analyses), the two flasks are left in place connected to the two equilibrators. This serves to prevent drying of the gas dispersers and to provide start-up samples to establish the concentration of  $\text{CO}_2$  in the pumps and gas lines before the analysis of fresh samples. In addition, use of such samples—with known  $p(\text{CO}_2)$ —provides a check on the system prior to the analysis of fresh samples.

# 8. Calculation and expression of results

## 8.1 Calculation of gas chromatograph response

The response of a flame ionization detector is almost linear over a large dynamic range. However, the response varies with changes in ambient temperature and with the flow rates of the hydrogen and oxygen reaching the flame. A quadratic curve will fit the actual response closely at any given time. With an infrared analyzer, which is not as linear, it will be necessary to run more than three standards to reduce the potential errors for concentrations not well represented by standards.

The detector peak area ( $A_x$ ) corresponds to the dry  $\text{CO}_2$  content— $x(\text{CO}_2)$ —of each of the three calibration gases. The peak area is linearly interpolated in time

between a pair of measurements (made at times  $t_1$  and  $t_2$ ) to estimate the response of the system at the time ( $t$ ) of measurement of each unknown:

$$A_x(t) = A_x(t_1) + \frac{t - t_1}{t_2 - t_1} [A_x(t_2) - A_x(t_1)]. \quad (2)$$

A separate response curve of peak area versus concentration is then calculated at the time of measurement of each unknown ( $t$ ):

$$x(\text{CO}_2) \cdot p = a_0 + a_1 \cdot A_x(t) + a_2 \cdot [A_x(t)]^2 \quad (3)$$

where  $p$  is the measured atmospheric pressure<sup>4</sup>.

## 8.2 Corrections for sample perturbation during equilibration

Some  $\text{CO}_2$  will be exchanged between the sea water sample and the air of the headspace during the process of equilibration. This process will alter the total dissolved inorganic carbon ( $C_T$ ) in the sea water sample while leaving the total alkalinity ( $A_T$ ) constant. The measured partial pressure will be in equilibrium with this modified sample. A mass balance approach is used to estimate the partial pressure of carbon dioxide in air that would have been in equilibrium with the original, unchanged sample. Although it is useful to have measurements of  $C_T$ , rough estimates will suffice for this calculation.

### 8.2.1 Calculation of $\Delta C_T$

The change in the number of moles of  $\text{CO}_2$ — $\Delta n(\text{CO}_2)$ —in the equilibrator headspace can be calculated (assuming ideal behavior),

$$\Delta n(\text{CO}_2) = \frac{[p(\text{CO}_2)_1 - p(\text{CO}_2)_2]V_H}{RT} \quad (4)$$

where  $V_H$  is the volume of air in the headspace and the subscripts 1 and 2 refer to values measured before and after the equilibration process, respectively. Note that the temperature of the system and the headspace volume are assumed to remain constant throughout. The change in  $C_T$  can then be calculated,

$$\Delta C_T = \frac{\Delta n(\text{CO}_2)}{\rho \cdot V_S} \quad (5)$$

where  $V_S$  is the volume of sea water of density  $\rho$  that was equilibrated with the headspace gas.

### 8.2.2 Calculation of corrected $p(\text{CO}_2)$

If the  $C_T$  of the unperturbed sample is known:

<sup>4</sup> The pressure in the loop is controlled at atmospheric pressure which is measured at the time of injection. The calibration gases are vented directly to the atmosphere to achieve this; air in equilibrium with the sample is in pressure equilibrium with the atmosphere through a flexible rubber diaphragm. Thus, the measured response curve relates partial pressure of  $\text{CO}_2$  (rather than concentration) to peak area.

- Calculate the  $C_T$  of the perturbed water sample and use this together with  $p(\text{CO}_2)$  to calculate the value of  $A_T$  for the sea water sample (see Annexe to Chapter 2)<sup>5</sup>. The equilibrium constants used should be appropriate to the equilibration temperature and the salinity of the sample being equilibrated<sup>6</sup>.
- Calculate  $p(\text{CO}_2)$  ( $\approx f(\text{CO}_2)$ ) for the unperturbed sea water from the knowledge of  $A_T$  and  $C_T$  (see Annexe to Chapter 2).

If the  $A_T$  of the original sample is known:

- Use  $p(\text{CO}_2)$  together with  $A_T$  to calculate the  $C_T$  of the perturbed water sample (see Annexe to Chapter 2)<sup>5</sup>. The equilibrium constants used should be appropriate to the equilibration temperature and the salinity of the sample being equilibrated<sup>6</sup>.
- Use equation (5) to estimate  $C_T$  in the unperturbed sample.
- Calculate  $p(\text{CO}_2)$  ( $\approx f(\text{CO}_2)$ ) for the unperturbed sea water from the knowledge of  $A_T$  and  $C_T$  (see Annexe to Chapter 2).

### 8.3 Correction for water vapor pressure

If the equilibrated air is injected into the gas chromatograph without removal of water vapor, the calculation outlined in section 8.2 will give the final value of  $p(\text{CO}_2)$  at equilibration pressure.

If water vapor was removed from the equilibrated air prior to injection into the gas chromatograph, it is necessary to correct for this. The partial pressure of  $\text{CO}_2$  in the dried air must be reduced by a factor which accounts for the increase in concentration of  $\text{CO}_2$  in the air resulting from the removal of the water vapor.

$$p(\text{CO}_2) = p(\text{CO}_2 \text{ in dry air}) \times [1 - p_\sigma(\text{H}_2\text{O})] \quad (6)$$

where  $p_\sigma(\text{H}_2\text{O})$  is the water vapor pressure over a sea water sample of a given salinity at the temperature of equilibration<sup>7</sup>—see Chapter 5, section 3.

### 8.4 Calculation of $f(\text{CO}_2)$ from corrected $p(\text{CO}_2)$

See SOP 24.

### 8.5 Example calculation

Flask volume = 525 cm<sup>3</sup>,

Flask headspace = 45 cm<sup>3</sup>,

Residual system volume (lines and pump) = 13 cm<sup>3</sup>,

<sup>5</sup> If desired it can be assumed that  $f(\text{CO}_2) \approx p(\text{CO}_2)$  for this calculation. Assuming that  $\text{CO}_2$  behaves ideally will not make a significant difference to the final result as long as the same assumption is made in both the forward and back calculations.

<sup>6</sup> As the same equilibrium constants (see Chapter 5) are used for the forward and back calculations, errors due to uncertainties in these will be small.

<sup>7</sup> Equation (6) assumes that the water vapor behaves ideally.

Fill gas (used to displace headspace),  $x(\text{CO}_2) = 750 \times 10^{-6}$ ,  
 Residual gas (lines and pump),  $x(\text{CO}_2) = 535 \times 10^{-6}$ ,  
 Temperature of gas in headspace = 25°C,  
 Salinity of sample = 35,  
 $C_T$  of sample (before equilibration) = 2050  $\mu\text{mol kg-soln}^{-1}$ ,  
 Equilibration pressure = 995 mbar (99.5 kPa),  
 Equilibration temperature = 20°C,  
 Measured  $x(\text{CO}_2)$  for sample =  $350 \times 10^{-6}$ .

From equation (4), for the headspace,

$$\begin{aligned}\Delta n(\text{CO}_2) &= \frac{(750 \times 10^{-6} - 350 \times 10^{-6}) \times 45 \times 10^{-6} \times 99500}{8.31447 \times 298.15} \\ &= 7.225 \times 10^{-7} \text{ mol},\end{aligned}$$

and for the residual gas in the lines and pump,

$$\begin{aligned}\Delta n(\text{CO}_2) &= \frac{(535 \times 10^{-6} - 350 \times 10^{-6}) \times 13 \times 10^{-6} \times 99500}{8.31447 \times 298.15} \\ &= 9.653 \times 10^{-8} \text{ mol}.\end{aligned}$$

Then at  $S = 35$  and  $T = 20^\circ\text{C}$ ,  $\rho_{\text{SW}} = 1024.76 \text{ kg m}^{-3}$  and from equation (5)

$$\Delta C_T = \frac{7.225 \times 10^{-7} + 9.653 \times 10^{-8}}{1024.76 \times (525 - 45) \times 10^{-6}} = 1.665 \times 10^{-6} \text{ mol kg}^{-1},$$

thus

$$C_T \text{ (after equilibration)} = 2050 + 1.665 = 2051.67 \mu\text{mol kg}^{-1}.$$

Total alkalinity ( $A_T$ ) in the sample is calculated from this together with the post-equilibration values of  $p(\text{CO}_2)$  (see Footnote 5).

As  $p(\text{CO}_2) = (350 \times 10^{-6}) \times (99.5/101.325) = 343.7 \mu\text{atm}$  and  $C_T = 2051.67 \mu\text{mol kg}^{-1}$ , using the equations in the Annexe to Chapter 2 together with the thermodynamic data in Chapter 5<sup>8</sup>,

$$A_T = 2348.21 \mu\text{mol kg}^{-1}.$$

The  $p(\text{CO}_2)$  of the sample before equilibration is then estimated from this value for  $A_T$  and  $C_T = 2050 \mu\text{mol kg}^{-1}$  (again, using the equations in the Annexe to Chapter 2 together with the thermodynamic data in Chapter 5) to give

$$p(\text{CO}_2) = 341.0 \mu\text{atm}.$$

## 9. Quality assurance

For general principles of analytical quality control see Chapter 3.

<sup>8</sup> If  $f(\text{CO}_2)$  is assumed  $\approx p(\text{CO}_2)$ , the calculated  $A_T = 2347.35 \mu\text{mol kg}^{-1}$ .

## 9.1 Stability of the response of the gas chromatograph

The performance of the gas chromatograph can be monitored by means of control charts (SOP 22) which give a visual indication of any significant change in the response of the instrument to injections of nearly constant amounts of  $\text{CO}_2$  calibration gases.

The absolute peak areas for the three calibration gases (normalized to a constant pressure and temperature) should be plotted against time and deviations of more than 2% should be investigated. As a rapid check on the functioning of the instrument, the values of the response function coefficients  $a_0$ ,  $a_1$ , and  $a_2$  can be printed with the calculated value of  $p(\text{CO}_2)$  for each analysis.

## 9.2 Reproducibility of equilibrated samples

Replicate samples should agree within 0.25% (see section 7.5); this test will give a rapid indication of deteriorating performance of the equilibration system. The fraction of analyses from each analytical session that fails to meet the criterion should be entered on a control chart, and any significant increase in these fractions investigated. As a further check on the functioning of the two equilibrators of the system, occasional duplicate samples should be taken from the same water sampler and run as a pair on the two equilibrators. Differences of greater than 0.5% in the corrected values should be cause for concern.

## 10. Bibliography

- Chipman, D.W., Takahashi, T., Breger, D. and Sutherland, S.C. 1992. Investigation of carbon dioxide in the South Atlantic and Northern Weddell Sea areas (WOCE sections A-12 and A-21) during the Meteor Expedition 11/5, January–March, 1990. Lamont-Doherty Geological Observatory of Columbia University. Final technical report for Grant No. DE-FG02-90ER60943.
- Wanninkhof, R. and Thoning, K. 1993. Measurement of fugacity of  $\text{CO}_2$  in surface water using continuous and discrete methods. *Mar. Chem.* **44**: 189–204.
- Weiss, R.F. 1981. Determinations of carbon dioxide and methane by dual catalyst flame ionization chromatography and nitrous oxide by electron capture chromatography. *J. Chromatogr. Sci.* **19**: 611–616.



## Annexe

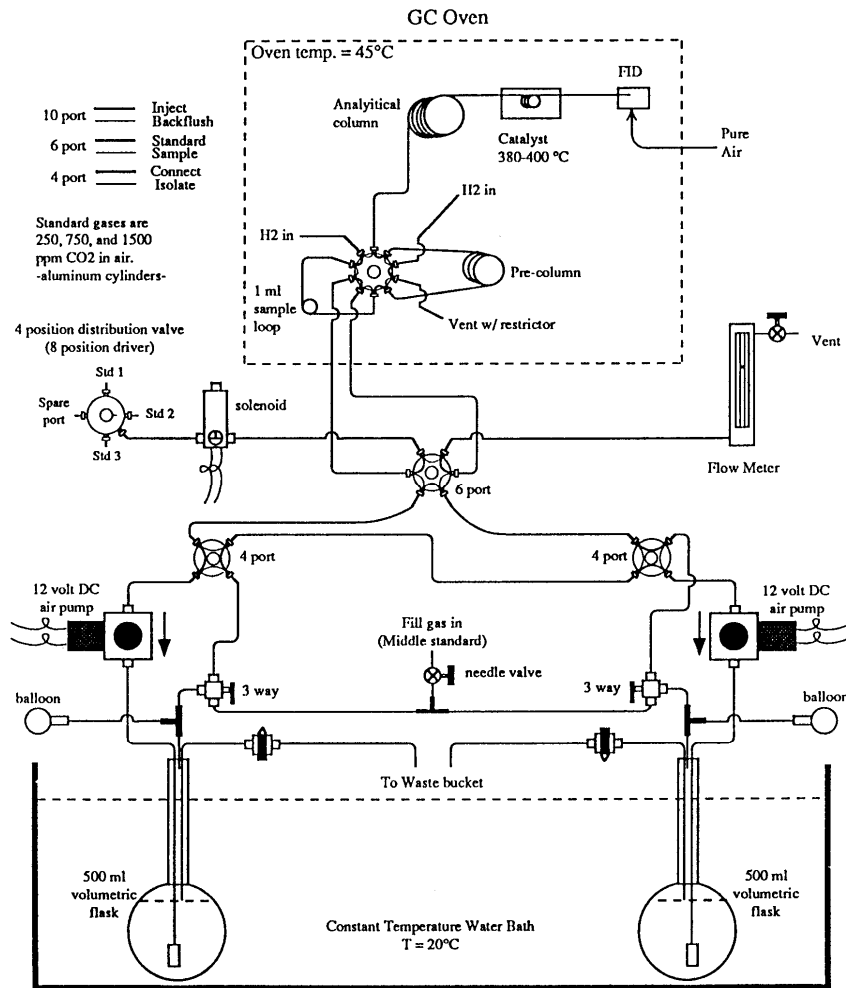

**Fig. 1** Schematic showing the gas-water equilibrators and gas chromatographic system for the equilibration of  $p(\text{CO}_2)$  in discrete samples (Chipman *et al.*, 1992).

# SOP 5

## Determination of $p(\text{CO}_2)$ in air that is in equilibrium with a continuous stream of sea water

### 1. Scope and field of application

This procedure describes a method for the determination of the partial pressure of carbon dioxide in air that is in equilibrium with a flowing stream of sea water, *e.g.*, that obtained by pumping surface sea water from the bow of a ship for underway analysis. The partial pressure of carbon dioxide is expressed as microatmospheres. The method is suitable for the assay of air in equilibrium with oceanic water samples (250–550  $\mu\text{atm}$ ).

### 2. Definition

The partial pressure of carbon dioxide in air that is in equilibrium with a sample of sea water is defined as the product of the mole fraction of  $\text{CO}_2$ ,  $x(\text{CO}_2)$ , in the equilibrated gas phase and the total pressure ( $p$ ) of equilibration:

$$p(\text{CO}_2) = x(\text{CO}_2) \cdot p . \quad (1)$$

It is a temperature-dependent property of the sea water sample; thus it is important to record the *in situ* water temperature as well as the water temperature in the equilibrator at the time of measurement.

### 3. Principle

A fixed volume of air is equilibrated with a stream of sea water that flows through an equilibrator<sup>1</sup>. As the volume of sea water that flows through the equilibrator is essentially infinite compared to the volume of air, the  $\text{CO}_2$  content of the air adjusts to equilibrium with the sea water without altering the  $\text{CO}_2$  content of the sea water appreciably. The air is circulated through a non-

---

<sup>1</sup> A number of effective designs exist for such an equilibrator. The most common is that designed by Dr. Ray Weiss at the Scripps Institution of Oceanography and described in a report by Butler *et al.* (1988). The apparatus described in this SOP also uses a rain type equilibrator, but it has approximately one tenth of the volume ( $\sim 1.3 \text{ dm}^3$ ) of the original Weiss design.

dispersive infra-red analyzer to measure its  $\text{CO}_2$  content<sup>2</sup>. The analyzer is calibrated using gases of known  $\text{CO}_2$  concentration (mole fraction).

The partial pressure,  $p(\text{CO}_2)$ , is then calculated from (1). To use this measurement together with other parameters of the carbon dioxide system in sea water, it is necessary to convert the mole fraction to fugacity,  $f(\text{CO}_2)$ , to account for the fact that  $\text{CO}_2$  does not strictly follow Henry's Law for ideal gases:

$$f(\text{CO}_2) = x(\text{CO}_2) \frac{p}{RT} \exp \left( \int_0^p V(\text{CO}_2) - RT/p' dp' \right) \quad (2)$$

(see Chapter 2). The calculations required are outlined in SOP 24.

## 4. Apparatus

The apparatus described here is intended to serve as an example of a commonly used system. It is based on a standardized design that is currently used on over a dozen ships at the time of writing<sup>3</sup>. Some of the details of flow rates and timing are “tuned” to this system and may need to be adjusted for systems with different components.

### 4.1 Outside air intake

A tube, typically Synflex<sup>®</sup> (formerly Dekoron<sup>®</sup>) type “1300”, is run from the measurement system to a location where uncontaminated outside air can be sampled. If the measurement system is located on board a ship, this line will typically be led to the bow of the ship<sup>4</sup>. The air is continually pumped at a rate of 2–3  $\text{dm}^3 \text{min}^{-1}$  to ensure constant flushing of the tubing. During sampling, a fraction (60–80  $\text{cm}^3 \text{min}^{-1}$ ) of the air stream is diverted through a dryer to the analyzer.

### 4.2 Equilibrator

The most common type of equilibrator involves a chamber where sea water is exposed to a headspace of air maintained at the ambient atmospheric pressure<sup>5</sup>.

<sup>2</sup> A gas chromatographic system can be used successfully for this measurement (see *e.g.*, Weiss, 1981; Weiss *et al.*, 1982; Robertson *et al.*, 1993; Weiss *et al.*, 1992). Although the gas chromatograph approach has a number of advantages in that it requires smaller amounts of both sample and calibration gas and is not sensitive to the  $\text{O}_2/\text{N}_2$  ratio of the gas being measured, the infrared approach is recommended here as being potentially more rugged and simpler to implement.

<sup>3</sup> A schematic of the layout described here is given in the Annexe to this procedure.

<sup>4</sup> It is important to record the relative wind speed and direction to confirm that the air being sampled represents uncontaminated marine air and does not contain any stack gas from the ship. Some investigators have reported that they believe that this air intake line can, in time, become contaminated with sea salt aerosols and then bleed  $\text{CO}_2$  slowly into the gas stream.

<sup>5</sup> Some equilibrator designs (*e.g.*, bubble or membrane type equilibrators) equilibrate at pressures different from ambient atmospheric pressure. These systems either need to

Rapid exchange of  $\text{CO}_2$  is facilitated by enhancing the surface area of water exposed to the headspace air (*e.g.*, raining sea water droplets through the headspace into a sea water reservoir at the bottom of the equilibrator). The water flow rate is  $2\text{--}5\text{ dm}^3\text{ min}^{-1}$  and can be dispersed using a standard gardening spray head. The sea water is removed from the reservoir using a gravity drain and a series of water traps to minimize air exchange between the lab and the equilibrator headspace. Ambient air pressure is maintained in the headspace with a vent tube that is open to the outside air. The vent tube should have a volume of at least 10% of the headspace volume so small high-frequency pressure fluctuations just move the headspace air in and out of the vent tube but do not draw in outside air. This can be accomplished by attaching a long tube to the vent that extends outside the ship. This also provides fresh air for the headspace rather than high- $\text{CO}_2$  lab air. A better option for ensuring that the uptake of air through the vent line does not significantly affect the headspace gas is to include a pre-equilibration chamber on the vent line. This is particularly important for equilibrators with a small headspace volume ( $< 2\text{ dm}^3$ ). The pre-equilibration chamber is a small chamber with sea water raining through it so any air brought into the headspace is already close to equilibrium with the sea water. During sampling, the headspace air is pumped through a dryer and the infrared detector at a rate of  $60\text{--}80\text{ cm}^3\text{ min}^{-1}$ . After passing through the detector, the equilibrated air is returned to the headspace to minimize the need for replacement air from the vent. It is important to keep track of temperature and pressure in the equilibrator at all times.

### 4.3 Drying system

It is desirable to dry all of the air streams going to the detector<sup>6</sup>. The drying system should be placed on the low-pressure side of any pump. Drying the air eliminates the possibility of condensation in the tubing leading to the analyzer; it also improves the sensitivity and the accuracy of the infrared analysis as it eliminates the need to correct for the pressure broadening of the  $\text{CO}_2$  band resulting from the presence of water. Also, the calibration gases are typically dry air, so it is preferable to also analyze the unknown samples under the same dry air conditions.

A number of approaches can be used to dry the air:

- Cooling the air to a specified dew point using a refrigeration unit (*e.g.*, Peltier cooler). This necessitates emptying the traps of the accumulated water (or ice) on a regular basis.
- Using a chemical drying agent, *e.g.*, Aquasorb<sup>®</sup>—a solid support impregnated with  $\text{P}_2\text{O}_5$  and containing a colored indicator (dew point  $-96^\circ\text{C}$ ). This drying agent will need to be replaced on a regular basis.
- Passing the wet sample gas through water permeable tubing (*e.g.*, Nafion<sup>®</sup>) with drying gas on the outside of the tubing to carry away the water vapor

---

use a second-stage equilibrator maintained at ambient pressure or apply a pressure correction term to adjust the values to ambient conditions.

<sup>6</sup> Some systems do not dry the gas streams. Instead, they use a two-channel infrared detector (*e.g.*, the LI-COR<sup>®</sup> Model 7000) to measure both the water and  $\text{CO}_2$  content, then correct for the water vapor in the final calculations. The advantage of these systems is the elimination of a complicated and potentially labor-intensive gas drying procedure.

and maintain a humidity gradient between the inside and the outside of the tubing.

The system described here combines a Peltier cooler and Nafion<sup>®</sup> tubing to dry the gases, but the analyses are made with a LI-COR<sup>®</sup> analyzer containing a water channel to ensure a complete accounting of any remaining water vapor.

#### 4.4 Calibration system

Because the infrared detector has a non-linear response to changing  $\text{CO}_2$  concentrations, it is recommended that multiple standards (3–6) be analyzed for the most accurate characterization of the response curve. Depending on whether the analyzer is run in absolute mode (*i.e.*, the reference cell is circulated with a closed loop of zero  $\text{CO}_2$  air) or in differential mode (*i.e.*, the reference cell is flushed with a known standard gas), it may be desirable to run the reference gas through the sample cell to “zero” the instrument. High-purity two-stage gas cylinder pressure regulators are needed for each of the standard gases, as well as a remotely operable valve for selecting between the different gas sources.

#### 4.5 Detector system

High quality infrared detectors can be purchased commercially. For operation on a ship, it is essential that the instrument not be sensitive to motion or vibration<sup>7</sup>. It is important to keep track of the temperature and pressure of the gas in the infrared absorption cells at the time of the measurements. If a water vapor correction is to be applied, then a detector with a water channel must be used.

#### 4.6 System control

Since the system is intended to operate in “underway” mode, there should be a program for autonomously controlling valve switching, monitoring flow rates and logging the necessary data. This program will require a microcomputer as well as digital and analog interface boards for controlling valves, solenoids and necessary sensors.

### 5. Reagents

#### 5.1 Compressed gases

The standards should be mixtures of  $\text{CO}_2$  in natural air (*i.e.*, containing  $\text{N}_2$ ,  $\text{O}_2$ , and trace gases) that bracket the expected concentrations of the samples as closely as possible (typically  $250\text{--}550 \times 10^{-6}$  for open ocean applications).  $\text{CO}_2$  concentrations have been found to be most stable in aluminum cylinders. The gases must be calibrated to better than the desired accuracy of the final measurements (*i.e.*, typically beyond the accuracy offered by commercial gas suppliers) and should be traceable to the World Meteorological Organization scale.

---

<sup>7</sup> Suitable instruments are available from LI-COR Environmental, 4647 Superior Street, P.O. Box 4425, Lincoln, NE 68504-0425, U.S.A.

## 5.2 Drying agents

Chemical drying agents are the most reliable way to ensure that the sample gas is dry. Even if condensing systems or drying tubes are used to primarily dry the gas, many systems also run the sample gas through a chemical drying agent as a final confirmation that the sample is dry. Some common drying agents are Aquasorb<sup>®</sup>, magnesium perchlorate or silica gel.

## 6. Sampling

As this procedure is for underway measurements, the sampling is done as part of the analysis. The important features are to ensure that the air line samples uncontaminated marine air (see section 4.1) and that the equilibrator samples uncontaminated surface sea water. As the  $p(\text{CO}_2)$  is very dependent on the water temperature, it is important that the water in the equilibrator be as close to sea surface temperature as possible. One should strive to set the system up in such a way that the difference in the temperature observed in the equilibrator and that observed in the surrounding sea water is less than  $0.5^\circ\text{C}$ . This is achieved by using a high flow rate of sea water to reduce the extent of the inevitable warming or cooling that occurs during passage from the water intake to the equilibrator. It is important to record the water intake temperature and salinity, *e.g.*, using a thermosalinograph system as well as the equilibrator temperature. The sea water temperature should be monitored with a sensor in the equilibrator and a sensor at the ship's sea water intake (outboard of any pumps or flow restrictors) so any temperature differences can be accounted for (see section 8.3) in the data reduction sequence. Because  $p(\text{CO}_2)$  is very sensitive to temperature, it is important to use high-quality sensors with confirmed accuracy by comparison with a National Institute of Standards ITS-90 traceable temperature sensor (confirmed calibration  $\pm 0.0001$  across the range)<sup>8</sup>. Comparison of the equilibrator and the sea surface temperature sensor readings can be done in a well stirred and insulated water bath either on the ship or in the laboratory, ideally over a range of temperatures with all sensors measuring at the same time. If the sensors vary from the traceable standard, then an offset can be applied.

## 7. Procedure

### 7.1 Introduction

The sequence of analyses outlined below is designed to measure both the marine air and the equilibrator in a cycle together with the calibration gases. The exact sequence is not critical and can be optimized for the particular location and desired objectives of the study. In general, the frequency of analysis is determined by the length-scale of the phenomena that are being observed (compared to the ship's speed), and by the desire to conserve calibration gases.

---

<sup>8</sup> To prove temperature traceability, a continuous path of calibrated measurements must be "traced" back to a fixed point of reference. This path consists of comparison measurements between "transfer standards" to ensure a temperature indication is an accurate reflection of the ITS-90 definition of temperature (see Chapter 3).

## 7.2 System calibration

A full set of standards should be run every 2.5 to 3 hours. Each standard takes approximately 4.5 minutes to analyze. After the gas selector valve is switched to a new standard, the system is allowed to flush through the detector for approximately 4 minutes with flow rates similar to the sample flow rates (60–80  $\text{cm}^3 \text{min}^{-1}$ ). After the lines are flushed, the flow is stopped at a point before the detector (*i.e.*, the detector is still vented to the atmosphere). After a delay of 6 seconds to allow for pressure equilibration in the detector, a 1-second averaged reading is taken. The gas selector valve is then switched to the next standard.

## 7.3 Cycle of analyses

Once the system has been calibrated, it alternates between marine air and equilibrated air readings. In the open ocean, sea water  $p(\text{CO}_2)$  generally has much larger variations than the marine air, so systems usually collect 5 to 10 times more equilibrator readings than marine air readings. Each time the gas selector valve is switched to a new gas, the air lines need to be thoroughly flushed with the new sample. After switching the gas selector valve to marine air, the detector is allowed to flush for 4 minutes. After flushing, the flow is stopped for 6 seconds and a 1-second averaged reading is taken. Flow is started again and the system is allowed to flush for 30 seconds before the flow is stopped for another reading. After 10 marine air readings are collected, the gas selector valve switches to equilibrator air and is allowed to flush for 4 minutes. After flushing, the flow is stopped for 6 seconds and the reading is taken. Flow is started again and the system is allowed to flush for 1 minute before the flow is stopped again for another reading. After 60 equilibrator readings, the system switches back to marine air. The sequence continues until it is time to standardize the system again.

# 8. Calculation and expression of results

## 8.1 Calculation of infrared detector response

The response of a non-dispersive infrared absorption detector is appreciably non-linear, even over the restricted range of  $\text{CO}_2$  concentrations that apply here. Furthermore, the detector signal depends in part on the number of moles of  $\text{CO}_2$  in the cell, not on the mole fraction. This is given by the gas law

$$n(\text{CO}_2) = \frac{x(\text{CO}_2) \cdot p \cdot V(\text{cell})}{RT} \cdot \phi \quad (3)$$

where  $\phi$  is an approximately constant term<sup>9</sup> that accounts for the non-ideality of the gas phase and  $p$  and  $T$  are the pressure and temperature of the gas, respectively, in the absorption cell, which has a volume  $V(\text{cell})$ <sup>10</sup>.

<sup>9</sup> Provided that the temperature, pressure and composition remain approximately constant. This is typically the case for this procedure.

<sup>10</sup> Absorption per mole of  $\text{CO}_2$  also increases with pressure and it has been found empirically (LI-COR, 1992) that (at a constant temperature) the pressure affects the signal voltage in a linear fashion.

Two approaches are commonly used to evaluate the mole fraction of an unknown sample, based on standards with a known mole fraction. The first approach is based on a factory-calibrated response curve for the instrument. The LI-COR<sup>®</sup> instruments come from the factory with a built-in response function. This response function is tuned for the particular environmental conditions by setting the “zero” and “span” parameters using standard gases (see LI-COR, 1992 for details). While this approach gives reasonable values over a very wide range of conditions, more accurate values can be achieved over the limited range of conditions observed in the open ocean.

The approach described here starts with the output mole fraction determined by the internal functions provided by the LI-COR<sup>®</sup> instruments as described in the first approach, then modifies the output based on a series of calibration standards analyzed as part of the sampling sequence. This approach is recommended for those using LI-COR<sup>®</sup> instruments because:

- 1) the  $x(\text{CO}_2)$  signal from RS-232 has better averaging (*i.e.*, the mV signal for the newer LI-COR<sup>®</sup> instruments is a converted digital signal that is not filtered or averaged);
- 2) the  $x(\text{CO}_2)$  signal is internally corrected for band broadening;
- 3) the  $x(\text{CO}_2)$  signal automatically takes cell pressure and temperature changes into account<sup>11</sup>.

Ideally, the instrument should be calibrated using the built-in zero and span functions at least once at the beginning of the cruise. Additional calibrations during the cruise should be bracketed by analyses of the full set of standards to document the change in nominal  $x(\text{CO}_2)$  output.

Following the analysis sequence outlined in section 7 provides nominal  $x(\text{CO}_2)$  values for the unknown samples bracketed in time by the analysis of a series of known standards. The proposed measurement cycle necessarily performs the measurements on each calibration gas, and on each sample of air, at different times. To ensure the highest measurement quality, it is necessary to interpolate the measurements on calibration gases so as to infer the appropriate calibration function at the exact time of the measurement of a sample of air (either atmospheric or from the equilibrator). This is achieved using a piecewise linear interpolation in time. The measured nominal  $x(\text{CO}_2)$  appropriate to a particular time  $t$  is estimated for each of the standard gases from values measured at times  $t_0$  and  $t_1$  that bracket time  $t$ :

$$C_0 + (C_1 - C_0) \frac{(t - t_0)}{(t_1 - t_0)}. \quad (4)$$

$C_0$  is the nominal concentration of the particular standard gas measured at time  $t_0$ , and  $C_1$  that measured at time  $t_1$ . This set of values is then used, together with the associated set of assigned  $x(\text{CO}_2)$  values for the standard gases, to estimate the coefficients of a linear calibration function appropriate to time  $t$ . This information is then used to calculate the nominal value of  $x(\text{CO}_2)$  for the air sample measured at time  $t$ :

---

<sup>11</sup> This requires an internal pressure transducer which some LI-COR<sup>®</sup> models may not have. In this case the pressure is a pre-set value.



$$y_s = A + Bx_s \quad (5)$$

where  $x_s$  and  $y_s$  are, respectively, the nominal value of  $x(\text{CO}_2)$  for the air sample and “true” value calculated from the calibration curve, and  $A$  and  $B$  are regression coefficients determined by a linear least-squares fit of the standards.

If the partial pressure of  $\text{CO}_2$  in dry air is required, it is necessary to multiply the corrected sample  $x(\text{CO}_2)$  by the equilibrator pressure  $P_{\text{eq}}$  (the pressure at the time of equilibration):

$$p(\text{CO}_2)_{T_E, \text{dry}} = x(\text{CO}_2) \cdot P_{\text{eq}} \quad (6)$$

where  $T_E$  is the temperature measured in the equilibrator.

## 8.2 Correction for water vapor pressure

Air in the equilibrator—like air at the sea surface—is assumed to be at 100% humidity. The partial pressure of  $\text{CO}_2$  measured in dried equilibrator air must therefore be reduced by a factor which accounts for the increase in concentration of  $\text{CO}_2$  in the air resulting from the removal of the water vapor.

Thus

$$p(\text{CO}_2)_{T_E, \text{wet}} = x(\text{CO}_2) [P_{\text{eq}} - VP(\text{H}_2\text{O})] \quad (7)$$

where  $VP(\text{H}_2\text{O})$  is the water vapor pressure over a sea water sample of a given salinity at the temperature of equilibration<sup>12</sup>—see Chapter 5.

## 8.3 Calculation of $f(\text{CO}_2)$ from $p(\text{CO}_2)$

If the  $p(\text{CO}_2)$  of the sea water is to be used to calculate—or compared with—the other parameters of the  $\text{CO}_2$  system, it is necessary to calculate the fugacity,  $f(\text{CO}_2)$ —see SOP 24:

$$f(\text{CO}_2)_{T_E} = p(\text{CO}_2)_{T_E, \text{wet}} \cdot \exp \left[ \frac{(B(\text{CO}_2)_{T_E} + 2 \cdot \delta(\text{CO}_2)_{T_E}) p_{\text{atm}}}{R \cdot T_E} \right] \quad (8)$$

where  $p_{\text{atm}}$  is the atmospheric pressure and  $B$  and  $\delta$  are defined in SOP 24. The term  $(x_C)^2$  is approximately equal to 1.

## 8.4 Correction of $f(\text{CO}_2)$ to sea surface temperature

The  $f(\text{CO}_2)$  measured in the equilibrator is appropriate to the temperature of the water in the equilibrator. To use this as information about gas exchange at the sea surface, it is necessary to correct the value obtained to the measured sea surface temperature:

$$f(\text{CO}_2)_{T_S, \text{wet}} = f(\text{CO}_2)_{T_E, \text{wet}} \cdot \exp[0.0423(T_S - T_E)] \quad (9)$$

<sup>12</sup> Equation (7) assumes that the water vapor behaves ideally.

where  $T_S$  is the sea surface temperature—typically the bulk temperature of the mixed layer<sup>13</sup>—and  $T_E$  is the temperature measured in the equilibrator<sup>14</sup>.

## 8.5 Example calculations

### 8.5.1 Calibration data

The calibrated  $x(\text{CO}_2)$  values for 4 standards are:

$$305.00, 370.00, 405.00 \text{ and } 500.00 \times 10^{-6}.$$

The measured  $x(\text{CO}_2)$  values at time  $t_0$  are:

$$\begin{aligned} 12:05 &= 305.06 \times 10^{-6}, \\ 12:10 &= 370.10 \times 10^{-6}, \\ 12:15 &= 405.21 \times 10^{-6}, \\ 12:20 &= 500.33 \times 10^{-6}. \end{aligned}$$

The measured  $x(\text{CO}_2)$  values at time  $t_1$  are:

$$\begin{aligned} 15:05 &= 305.56 \times 10^{-6}, \\ 15:10 &= 370.60 \times 10^{-6}, \\ 15:15 &= 405.71 \times 10^{-6}, \\ 15:20 &= 500.83 \times 10^{-6}. \end{aligned}$$

The interpolated  $x(\text{CO}_2)$  values at 13:00 are:

$$\begin{aligned} 305.06 + (305.56 - 305.06) \cdot \left(\frac{55}{180}\right) &= 305.21 \times 10^{-6}, \\ 370.10 + (370.60 - 370.10) \cdot \left(\frac{50}{180}\right) &= 370.24 \times 10^{-6}, \\ 405.21 + (405.71 - 405.21) \cdot \left(\frac{45}{180}\right) &= 405.34 \times 10^{-6}, \\ 500.33 + (500.83 - 500.33) \cdot \left(\frac{40}{180}\right) &= 500.44 \times 10^{-6}. \end{aligned}$$

### 8.5.2 Correction of nominal sample value

The nominal equilibrator air  $x(\text{CO}_2)$  was  $378.45 \times 10^{-6}$  at 13:00.

<sup>13</sup> There is still some discussion as to whether the appropriate choice of sea surface temperature that should be used to study air–sea exchange is that measured on the ship’s underway system (typically the bulk temperature of the mixed layer), or whether a “skin temperature” should be determined and used (see Robertson and Watson, 1992).

<sup>14</sup> The factor of 0.0423 has been determined experimentally (Takahashi *et al.*, 1993). A more elaborate correction procedure is possible (see, *e.g.*, Copin-Montegut, 1988; Goyet *et al.*, 1993); however, it is unnecessary provided that  $|T_S - T_E| < 1$  K, as is the case for most measurement systems.

$$A = 0.1813, B = 0.99876 \text{ from linear fit,}$$

$$y_s = 0.99876 \cdot 378.45 + 0.1813 = 378.16 \times 10^{-6}.$$

The final calibrated  $x(\text{CO}_2)$  value is  $378.16 \times 10^{-6}$ .

### 8.5.3 Conversion to $p(\text{CO}_2)$

The calibrated  $x(\text{CO}_2)$  value was  $378.16 \times 10^{-6}$  at  $P_{\text{eq}} = 101.802 \text{ kPa}$  (1.0047 atm).

Thus

$$p(\text{CO}_2)_{\text{TE, dry}} = (378.16 \times 10^{-6})(101802) = 38.498 \text{ Pa}$$

$$= 379.94 \mu\text{atm}.$$

### 8.5.4 Correction to 100% humidity

The water in the equilibrator has  $S = 35$  and  $T_E = 298.15 \text{ K}$  (25.00°C).

Thus

$$p_a(\text{H}_2\text{O}) = 3.1106 \text{ kPa (Chapter 5)}$$

$$= 0.0307 \text{ atm}$$

and from equation (7)

$$p(\text{CO}_2)_{\text{TE, wet}} = 378.16 \cdot (1.0047 - 0.0307)$$

$$= 368.33 \mu\text{atm}.$$

### 8.5.5 Calculation of $f(\text{CO}_2)$

The equilibrator pressure is  $P_{\text{eq}} = 101.802 \text{ kPa}$  and  $T_E = 298.15 \text{ K}$  (25.0°C), then

$$B(\text{CO}_2)_{\text{TE}} = -123.20 \text{ cm}^3 \text{ mol}^{-1},$$

$$\delta(\text{CO}_2)_{\text{TE}} = 22.52 \text{ cm}^3 \text{ mol}^{-1}.$$

So, from equation (8),

$$f(\text{CO}_2)_{T_E, \text{wet}} = 368.33 \cdot \exp \left[ \frac{(-123.20 \times 10^{-6} + 2(22.52 \times 10^{-6})) \times 101802}{8.314472 \times 298.15} \right]$$

$$= 367.15 \mu\text{atm}.$$

### 8.5.6 Correction to sea surface temperature

The sea surface temperature,  $T_S = 297.85 \text{ K}$  (24.70°C). Thus from equation (9),

$$f(\text{CO}_2)_{T_S, \text{wet}} = 367.17 \cdot \exp[0.0423 \cdot (297.85 - 298.15)]$$

$$= 362.52 \mu\text{atm}.$$

## 9. Quality assurance

### 9.1 For general principles of analytical quality control see Chapter 3

### 9.2 Specific applications of analytical quality control

#### 9.2.1 *Stability of the response of the infrared analyzer*

The performance of the infrared analyzer can be monitored by means of control charts (SOP 22) which give a visual indication of any significant change in the response of the instrument to  $\text{CO}_2$ . The offset between the cells should remain near zero. The nominal  $x(\text{CO}_2)$  values of standards should remain fairly stable.

#### 9.2.2 *Reproducibility of equilibrated samples*

An estimate of the reproducibility of the instrument can be obtained in areas where the rate of change is slow. For marine air samples, this should extend over wide areas; for water it is most striking in the central gyres. The standard deviation of the measurement can be calculated over the period that either ambient air or air from the equilibrator is being measured. The standard deviation should be monitored carefully; it should be less than  $0.3 \mu\text{atm}$  for ambient air and less than  $1 \mu\text{atm}$  for air from the equilibrator.

## 10. Bibliography

- Butler, J.H., Elkins, J.W., Brunson, C.M., Egan, K.B., Thompson, T.M., Conway, T.J. and Hall, B.D. 1988. Trace gases in and over the West Pacific and East Indian Oceans during the El Niño–Southern Oscillation event of 1987. NOAA Data Report, ERL-ARL-16, 104 pp. Air Resources Laboratory, Silver Spring, MD.
- Copin-Montegut, C. 1988. A new formula for the effect of temperature on the partial pressure of  $\text{CO}_2$  in seawater. *Mar. Chem.* **25**: 29–37.
- Goyet C., Millero, F.J., Poisson, A. and Schafer, D. 1993. Temperature dependence of  $\text{CO}_2$  fugacity in seawater. *Mar. Chem.* **44**: 205–219.
- LI-COR. 1992. LI-6251  $\text{CO}_2$  analyzer operating and service manual. LI-COR, Inc. Publication No. 8712-56, Revision 1.
- Robertson, J.E. and Watson, A.J. 1992. Surface thermal skin effect and the uptake of atmospheric  $\text{CO}_2$  by the ocean. *Nature* **358**: 738–740.
- Robertson, J.E., Watson, A.J., Langdon, C., Ling, R.D. and Wood, J. 1993. Diurnal variation in surface  $p\text{CO}_2$  and  $\text{O}_2$  at  $60^\circ \text{N}$  and  $20^\circ \text{W}$  in the North Atlantic. *Deep-Sea Res.* **40**: 409–423.
- Takahashi, T., Olafsson, J., Goddard, J.G., Chipman, D.W. and Sutherland, S.C. 1993. Seasonal variation of  $\text{CO}_2$  and nutrients in the high-latitude surface oceans: a comparative study. *Global Biogeochem. Cycles* **7**: 843–878.
- Weiss, R.F. 1981. Determinations of carbon dioxide and methane by dual catalyst flame ionization chromatography and nitrous oxide by electron capture chromatography. *J. Chromatogr. Sci.* **19**: 611–616.
- Weiss, R.F., Jahnke, R.A. and Keeling, C.D. 1982. Seasonal effects of temperature and salinity on the partial pressure of carbon dioxide in seawater. *Nature* **300**: 511–513.
- Weiss, R.F., Van Woy, F.A. and Salameh, P.K. 1992. Surface water and atmospheric carbon dioxide and nitrous oxide observations by shipboard automated gas chromatography: Results from expeditions between 1977 and 1990. Scripps Institution of Oceanography Reference 92-11. ORNL/CDIAC-59 NDP-044. Carbon Dioxide Information Analysis Center, Oak Ridge National Laboratory, Oak Ridge, Tennessee, 144 pp.

# Annexe

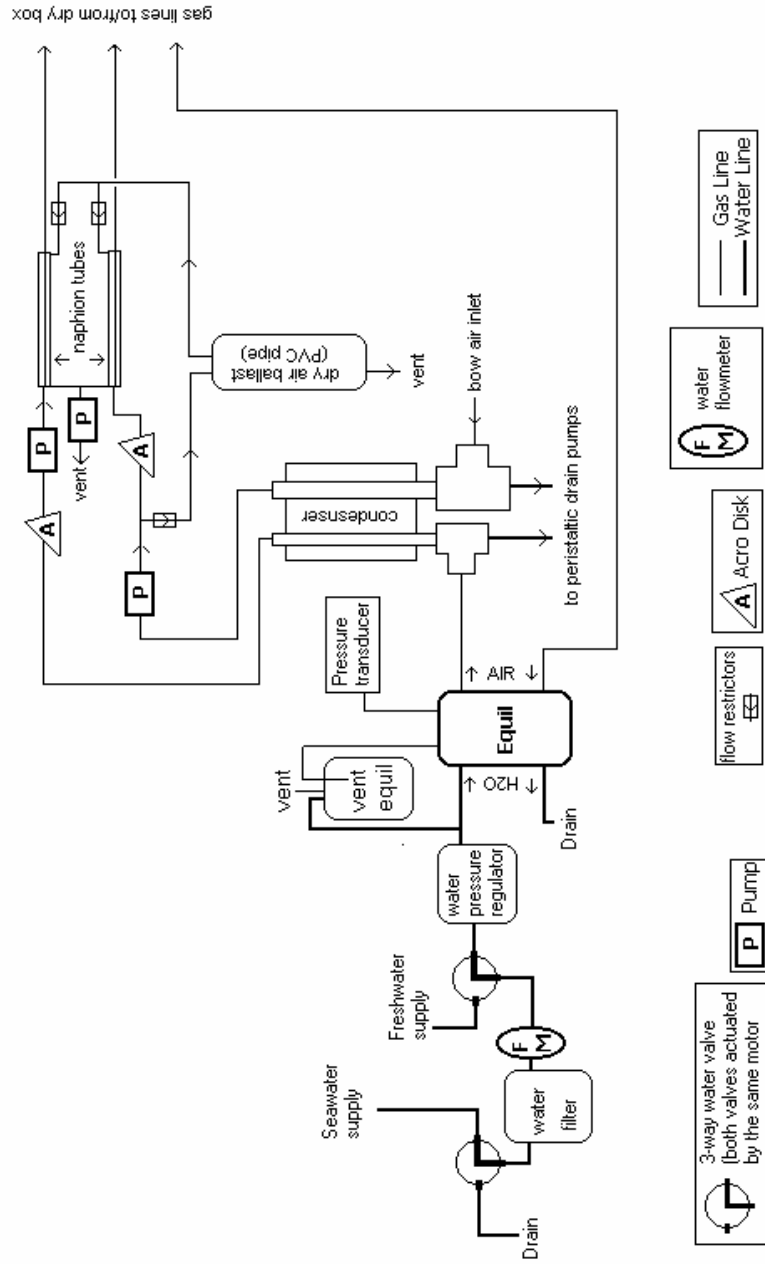

**Fig. 1** Schematic showing the layout of the analytical system described here (based on system designed by Craig Neill, Bjerknes Center for Climate Research, Norway).

# SOP 6a

## Determination of the pH of sea water using a glass /reference electrode cell

### 1. Scope and field of application

This procedure describes a method for the potentiometric determination of the pH of sea water on the total hydrogen ion concentration pH scale. The total hydrogen ion concentration,  $[H^+]$ , is expressed as moles per kilogram of sea water.

### 2. Definition

The total hydrogen ion concentration of sea water includes the contribution of the medium ion sulfate and is defined as

$$\begin{aligned} [H^+] &= [H^+]_F (1 + S_T / K_S) \\ &\approx [H^+]_F + [HSO_4^-] \end{aligned} \quad (1)$$

where  $[H^+]_F$  is the *free* concentration of hydrogen ion in sea water,  $S_T$  is the total sulfate concentration ( $[HSO_4^-] + [SO_4^{2-}]$ ) and  $K_S$  is the acid dissociation constant for  $HSO_4^-$ . The pH is then defined as the negative of the base 10 logarithm of the hydrogen ion concentration:

$$pH = -\log_{10} \left( \frac{[H^+]}{\text{mol kg-soln}^{-1}} \right). \quad (2)$$

### 3. Principle

Values of pH are determined experimentally from sequential measurements of the e.m.f. ( $E$ ) of the cell

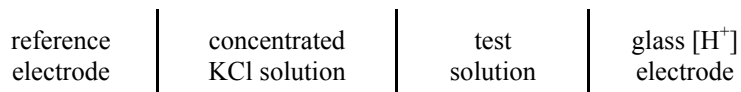

in a standard buffer (S) of known (defined) pH and in the sea water sample (X).

The operational pH is defined by the expression

$$\text{pH}(X) = \text{pH}(S) + \frac{E_s - E_x}{RT \ln 10 / F} . \quad (3)$$

Residual liquid junction error is minimized by matching the composition of the standard buffer to the sea water sample, *i.e.*, by making the buffer up in synthetic sea water.

Values of pH(S) have been assigned to various standard buffers in synthetic sea water. These are based on careful laboratory measurements made using cells without liquid junction.

## 4. Apparatus

### 4.1 pH cell

A combination glass/reference electrode is typically the most convenient cell to use; however, measurement quality can often be improved by using separate glass and reference electrodes.

### 4.2 Voltmeter with high input impedance

The e.m.f. of the glass/reference electrode cell can be measured with a pH meter or other voltmeter with a high input impedance ( $>10^{13} \Omega$ ). If a pH meter with a sensitivity of  $\pm 0.1$  mV is used to measure the e.m.f., the sensitivity in determining the pH is  $\pm 0.002$  pH units. The use of a  $5\frac{1}{2}$  digit voltmeter with a high input impedance<sup>1</sup> can improve the sensitivity to better than  $\pm 0.001$  pH units. (The accuracy of the measurement is dependent upon the reliability of the assignment of pH(S) values to the calibration buffers used.)

### 4.3 Closed measurement container

It is necessary to measure the pH on a sample that has not had the opportunity to exchange CO<sub>2</sub> with the atmosphere so as to ensure reliable pH results.

### 4.4 Thermometer (accurate to $\pm 0.05^\circ\text{C}$ )

The temperature should be known or controlled to within  $0.1^\circ\text{C}$  during the measurement.

---

<sup>1</sup> An external circuit based on a high input impedance operational amplifier (*e.g.*, an FET electrometer amplifier) configured as a voltage follower (unity gain amplifier) can be used to achieve this.

## 5. Reagents

### 5.1 Synthetic sea water

- Reagent grade NaCl (dried in an oven at 110°C),
- Reagent grade Na<sub>2</sub>SO<sub>4</sub> (dried in an oven at 110°C),
- Reagent grade KCl (dried in an oven at 110°C),
- Calibrated solution of reagent grade MgCl<sub>2</sub>,<sup>2</sup>
- Calibrated solution of reagent grade CaCl<sub>2</sub>,<sup>2</sup>
- Deionized water.

### 5.2 Buffer substances

- Calibrated solution of HCl prepared from redistilled reagent grade HCl. Its concentration should be known to within 0.1%<sup>3</sup>.
- 2-amino-2-hydroxymethyl-1,3-propanediol (“TRIS”), crushed and dried in a desiccator at room temperature over phosphorus (V) oxide before use.
- 2-aminopyridine, recrystallized from a benzene–petroleum ether mixture, crushed and dried in a desiccator at room temperature over phosphorus (V) oxide before use.

## 6. Sampling

It is essential that the samples analyzed are collected, poisoned, and stored according to the procedures detailed in SOP 1. Care should be taken to avoid the exchange of CO<sub>2</sub> with the atmosphere both during sampling and during subsequent manipulation.

## 7. Procedure

### 7.1 Preparation of buffers in synthetic sea water

The compositions of a TRIS/HCl buffer and of a 2-aminopyridine/HCl buffer in synthetic sea water with a salinity of 35 are given in Table 1. This recipe is based on synthetic sea water (see Chapter 5, Table 4) in which 0.04 mol/kg-H<sub>2</sub>O of NaCl has been replaced with HCl, and contains a total of 0.08 mol/kg-H<sub>2</sub>O of the desired base. The simplest way to prepare this buffer accurately is first to weigh out the hydrochloric acid and then to scale the amounts of the other constituents to match the exact amount of HCl that was weighed out. Such buffers can be stored for a number of weeks, in a sealed, almost full, container.

---

<sup>2</sup> Solutions of MgCl<sub>2</sub> and CaCl<sub>2</sub> can be analyzed either by measuring the density of the stock solution, by titrating with a calibrated silver nitrate solution (*e.g.*, using K<sub>2</sub>CrO<sub>4</sub> as an indicator) or by gravimetric precipitation of chloride.

<sup>3</sup> Solutions of HCl can be analyzed accurately by coulometric titration, by a careful titration against a standard base (*e.g.*, TRIS—NIST 723) or by gravimetric precipitation of chloride.



**Table 1** Composition of a buffer solution for pH in synthetic sea water of salinity 35 (weights based on 1000 g of H<sub>2</sub>O).

Constituent	Moles	Weight (g) <sup>a</sup>
NaCl	0.38762 <sup>b</sup>	22.6446
KCl	0.01058	0.7884
MgCl <sub>2</sub>	0.05474	—
CaCl <sub>2</sub>	0.01075	—
Na <sub>2</sub> SO <sub>4</sub>	0.02927	4.1563
HCl	0.04000	—
<i>One of:</i>		
2-amino-2-hydroxymethyl-1,3-propanediol (TRIS)	0.08000	9.6837
2-aminopyridine	0.08000	7.5231
<i>Total weight of solution containing:</i>		
2-amino-2-hydroxymethyl-1,3-propanediol (TRIS)	—	1044.09
2-aminopyridine	—	1041.93

<sup>a</sup> Weight in air at sea level (*i.e.*, not corrected to mass). If a weight is not given, the component is added as the appropriate amount of a calibrated solution.

<sup>b</sup>  $m(\text{NaCl}) = 0.42762 - 0.04 \text{ mol/kg-H}_2\text{O}$ , *i.e.*, replacing NaCl with HCl.

To compute the composition for a buffer with a salinity different from 35<sup>4</sup>, first compute the composition of the basic artificial sea water—containing no base or HCl and with the full amount of NaCl—corresponding to the new salinity,  $S$ :

$$m_S = m_{35} \times \frac{25.5695S}{1000 - 1.0019S}, \quad (4)$$

then adjust the  $m(\text{NaCl})$  down by 0.04 mol/kg-H<sub>2</sub>O and add 0.08 mol/kg-H<sub>2</sub>O of base.

## 7.2 Confirm response of pH cell<sup>5</sup>

Before a pH cell (a glass electrode/reference electrode pair) is used to measure pH, it should be tested to ensure that it is performing properly, *i.e.*, that it has an ideal Nernst response.

Bring both buffers (TRIS and 2-aminopyridine) to the same known temperature (*e.g.*, 25°C). Measure and record the e.m.f. of the pH cell in each buffer. The difference in the e.m.f. is used to check the response of the pH cell (see

<sup>4</sup> The magnitude of the error involved in using a salinity 35 buffer for most oceanic measurements (*i.e.*, in the salinity range 33–37) is probably less than 0.005 in pH. For a more complete discussion of this error see Whitfield *et al.* (1985) and Butler *et al.* (1985).

<sup>5</sup> Some investigators make use of the titration curve obtained from titrating a sodium chloride solution with HCl (see SOP 3) to confirm that the electrode pair has the theoretical response ( $RT/F$ ). However, the value of the slope and the value of  $E^\circ$  obtained by fitting experimental results in this fashion are highly correlated and thus not particularly reliable. It is better to verify the response of the electrode pair used with suitable buffers, as is done here.

section 8.1). If the response is not theoretical (within the experimental uncertainty), the electrodes should be rejected. E.m.f. readings obtained with a well-behaved pH cell should be stable with time (drift < 0.05 mV min<sup>-1</sup>)<sup>6</sup>.

### 7.3 Measurement of pH

Bring the TRIS buffer and the sea water samples to be measured to the same known temperature (*e.g.*, 25°C). The e.m.f. of the pH cell is then measured, first in the TRIS buffer ( $E_S$ ) and then in the sea water sample ( $E_X$ ). Care should be taken to minimize any exposure of the sea water samples to the atmosphere so as to limit loss or gain of CO<sub>2</sub>.

## 8. Calculation and expression of results

### 8.1 Calculation of response of pH cell

The defined pH values of the two buffers recommended for use in this procedure are:

*2-amino-2-hydroxy-1,3-propanediol (TRIS)*

$$\begin{aligned} \text{pH(S)} = & (11911.08 - 18.2499S - 0.039336S^2) \frac{1}{T/\text{K}} \\ & - 366.27059 + 0.53993607S + 0.00016329S^2 \\ & + (64.52243 - 0.084041S) \ln(T/\text{K}) - 0.11149858(T/\text{K}). \end{aligned} \quad (5)$$

*2-aminopyridine (AMP)*

$$\begin{aligned} \text{pH(S)} = & (111.35 + 5.44875S) \frac{1}{T/\text{K}} + 41.6775 - 0.015683S \\ & - 6.20815 \ln(T/\text{K}) - \log_{10}(1 - 0.00106S). \end{aligned} \quad (6)$$

The electrode response,  $s$ , can then be calculated:

$$s = \frac{E_{\text{AMP}} - E_{\text{TRIS}}}{\text{pH(S)}_{\text{TRIS}} - \text{pH(S)}_{\text{AMP}}} \quad (7)$$

and compared with the ideal Nernst value:  $RT \ln 10 / F$ . If it is more than about 0.3% different, the pH cell should be replaced.

### 8.2 Calculation of pH

Values of pH are calculated from the expression

$$\text{pH(X)} = \text{pH(S)} + \frac{E_S - E_X}{RT \ln 10 / F} \quad (8)$$

<sup>6</sup> This is an upper limit to the acceptable level of drift. An ideal level is as much as an order of magnitude lower, *e.g.*, < 0.3 mV h<sup>-1</sup>.

where  $\text{pH(S)}$ , the pH of TRIS buffer (Table 1) on the total hydrogen ion scale (expressed in  $\text{mol kg-soln}^{-1}$ ) is given by equation (5).

### 8.3 Example calculation

Input data:

$$\begin{aligned}t &= 25^\circ\text{C} \text{ (i.e., } T = 298.15 \text{ K)}, \\S &= 35, \\E_{\text{TRIS}} &= -0.0724 \text{ V}, \\E_{\text{AMP}} &= 0.0049 \text{ V}, \\E_{\text{X}} &= -0.0670 \text{ V}.\end{aligned}$$

Hence

$$\begin{aligned}\text{pH(S)}_{\text{TRIS}} &= 8.0936, \\ \text{pH(S)}_{\text{AMP}} &= 6.7866, \\ RT \ln 10/F &= 0.05916 \text{ V/pH unit}.\end{aligned}$$

Thus

$$s = \frac{0.0049 - (-0.0724)}{8.0936 - 6.7866} = 0.05914 \text{ V / pH unit}$$

and, using equation (8),

$$\text{pH(X)} = 8.0936 + \frac{-0.0724 - (-0.0670)}{0.05916} = 8.0023.$$

## 9. Quality assurance

### 9.1 For general principles of analytical quality control see Chapter 3

### 9.2 Specific applications of analytical quality control

#### 9.2.1 Ideality of pH cell behavior

The measured electrode response,  $s$ , should be compared with ideal Nernst behavior on a regular basis (see section 7.2). If the value is more than 0.3% from theoretical, try cleaning the glass electrode of surface deposits and measuring again. If the discrepancy persists, the electrode should be replaced.

The value of  $E_{\text{S}}$  in TRIS buffer, when measured at a constant temperature (*e.g.*,  $25^\circ\text{C}$ ), should remain stable to within a few mV. A sudden change in  $E_{\text{S}}$  is indicative of potential problems. Similarly, the e.m.f. of a well-behaved pH cell immersed in a thermostated buffer should be stable (drift  $< 0.05 \text{ mV min}^{-1}$ ).

### 9.2.2 Precision

A precision of 0.003 pH units (1 SD) is possible with care. Plot the results of duplicate analyses on a range control chart (SOP 22).

### 9.2.3 Bias

The bias of potentiometric pH measurements depends on the care with which the buffer was prepared, especially with regard to the ratio between the TRIS and the HCl, and on the accuracy with which the values of pH(S) were originally assigned. This latter value has been estimated as being within 0.004 pH units.

## 10. Bibliography

- Bates, R.G. and Erickson, W.P. 1986. Thermodynamics of the dissociation of 2-aminopyridinium ion in synthetic seawater and a standard for pH in marine systems. *J. Soltn. Chem.* **15**: 891–901.
- Butler, R.A., Covington, A.K. and Whitfield, M. 1985. The determination of pH in estuarine waters. II: Practical considerations. *Oceanol. Acta* **8**: 433–439.
- DelValls, T.A. and Dickson, A.G. 1998. The pH of buffers based on 2-amino-2-hydroxymethyl-1,3-propanediol ('tris') in synthetic sea water. *Deep-Sea Res.* **45**: 1541–1554.
- Dickson, A.G. 1993. pH buffers for sea water media based on the total hydrogen ion concentration scale. *Deep-Sea Res.* **40**: 107–118.
- Dickson, A.G. 1993. The measurement of sea water pH. *Mar. Chem.* **44**: 131–142.
- Millero, F.J., Zhang, J.-Z., Fiol, S., Sotolongo, S., Roy, R.N., Lee, K. and Mane, S. 1993. The use of buffers to measure the pH of sea water. *Mar. Chem.* **44**: 143–152.
- Nemzer, B.V. and Dickson, A.G. 2004. The stability and reproducibility of Tris buffers in synthetic seawater. *Mar. Chem.* **96**: 237–242.
- Ramette, R.W., Culbertson, C.H. and Bates, R.G. 1977. Acid-base properties of tris(hydroxymethyl)aminomethane (tris) buffers in seawater from 5 to 40°C. *Anal. Chem.* **49**: 867–870.
- Whitfield, M., Butler, R.A. and Covington, A.K. 1985. The determination of pH in estuarine waters. I. Definition of pH scales and the selection of buffers. *Oceanol. Acta* **8**: 423–432.

# SOP 6b

## Determination of the pH of sea water using the indicator dye *m*-cresol purple

### 1. Scope and field of application

This procedure describes a method for the spectrophotometric determination of the pH of sea water on the total hydrogen ion concentration pH scale. The total hydrogen ion concentration,  $[H^+]$ , is expressed as moles per kilogram of sea water.

### 2. Definition

The total hydrogen ion concentration of sea water includes the contribution of the medium ion sulfate and is defined as

$$\begin{aligned} [H^+] &= [H^+]_F (1 + S_T / K_S) \\ &\approx [H^+]_F + [HSO_4^-] \end{aligned} \quad (1)$$

where  $[H^+]_F$  is the *free* concentration of hydrogen ion in sea water,  $S_T$  is the total sulfate concentration ( $[HSO_4^-] + [SO_4^{2-}]$ ) and  $K_S$  is the acid dissociation constant for  $HSO_4^-$ . The pH is then defined as the negative of the base 10 logarithm of the hydrogen ion concentration:

$$pH = -\log_{10} \left( \frac{[H^+]}{\text{mol kg-soln}^{-1}} \right). \quad (2)$$

### 3. Principle

The values of pH are determined by adding an indicator dye to sea water. For the sulfonephthalein indicators such as *m*-cresol purple, the reaction of interest at sea water pH is the second dissociation

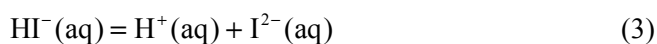

where *I* represents the indicator dye, which is present at a low level in a sea water sample. The total hydrogen ion concentration of the sample can then be determined:

$$\text{pH} = \text{p}K(\text{HI}^-) + \log_{10} \frac{[\text{I}^{2-}]}{[\text{HI}^-]} \quad (4)$$

The principle of this approach uses the fact that the different forms of the indicator have substantially different absorption spectra. Thus the information contained in the composite spectrum can be used to estimate  $[\text{I}^{2-}]/[\text{HI}^-]$ .

At an individual wavelength,  $\lambda$ , the measured absorbance in a cell with a path length,  $l$ , is given by the Beer–Lambert law as

$$\frac{A_\lambda}{l} = \varepsilon_\lambda(\text{HI}^-)[\text{HI}^-] + \varepsilon_\lambda(\text{I}^{2-})[\text{I}^{2-}] + B_\lambda + e \quad (5)$$

where  $B_\lambda$  corresponds to the background absorbance of the sample and  $e$  is an error term due to instrumental noise. Provided that the values of the extinction coefficients:  $\varepsilon_\lambda(\text{HI}^-)$  and  $\varepsilon_\lambda(\text{I}^{2-})$  have been measured as a function of wavelength, absorbance measurements made at two or more wavelengths can be used to estimate the ratio  $[\text{I}^{2-}]/[\text{HI}^-]$ .

In the case that only two wavelengths are used, and provided that the background can be eliminated effectively by a subtractive procedure, (5) can be rearranged to give (assuming no instrumental error)

$$\frac{[\text{I}^{2-}]}{[\text{HI}^-]} = \frac{A_1 / A_2 - \varepsilon_1(\text{HI}^-) / \varepsilon_2(\text{HI}^-)}{\varepsilon_1(\text{I}^{2-}) / \varepsilon_2(\text{I}^{2-}) - (A_1 / A_2) \varepsilon_2(\text{I}^{2-}) / \varepsilon_2(\text{HI}^-)} \quad (6)$$

where the numbers 1 and 2 refer to the wavelengths chosen. For the best sensitivity, the wavelengths corresponding to the absorbance maxima of the base ( $\text{I}^{2-}$ ) and acid ( $\text{HI}^-$ ) forms, respectively, are used. The various terms  $\varepsilon$  are the extinction coefficients of the specified species at wavelengths 1 and 2, respectively.

## 4. Apparatus

### 4.1 Flexible drawing tube

Approximately 40 cm long, sized to fit snugly over cell port. Silicone rubber is suitable for this (see Footnote 1 in SOP 1).

### 4.2 Spectrophotometric cells

These should be made of optical glass with a 10 cm path-length, two ports and polytetrafluoroethylene (Teflon<sup>®</sup>) stoppers. A sufficient number of cells are needed to collect all the samples that will be analyzed from a particular cast (see section 6).

### 4.3 Micropipette

A micropipette is used to add the dye to the cell. It should be of  $\sim 0.1 \text{ cm}^3$  capacity with a narrow Teflon<sup>®</sup> tube attached to act as a nozzle.

### 4.4 High-quality spectrophotometer

For work of the highest sensitivity and precision, a double-beam spectrophotometer is desirable. However, good results can be obtained with a high-quality single-beam instrument.

### 4.5 Temperature-control system for spectrophotometer cell

Commercially manufactured, thermostated spectrophotometer compartments that can accommodate 10 cm cells are rarely available and one will probably have to be custom-made. The temperature should be regulated to within  $0.1^\circ\text{C}$ .

### 4.6 System to warm samples to measurement temperature

Although it is possible to warm up the cells containing samples in Ziploc<sup>®</sup> bags in a thermostat bath, this is inconvenient. It is much better to build a custom-made thermostated compartment that can hold approximately 12 cells at once without getting them wet.

### 4.7 Thermostat bath ( $\pm 0.05^\circ\text{C}$ )

A thermostat bath is used to regulate the temperature of the cell compartment and the temperature of the system described in section 4.6.

## 5. Reagents

### 5.1 Solution of *m*-cresol purple

A concentrated (at least  $2 \text{ mmol dm}^{-3}$ ) dye solution of known pH adjusted to be in the range  $7.9 \pm 0.1$  pH units—chosen to match pH measurements from an oceanic profile—is required; this implies that for *m*-cresol purple  $A_1/A_2 \approx 1.6$ .<sup>1</sup>

## 6. Sampling

Draw the sample—using the drawing tube—directly from the Niskin bottle (or other water sampler) into the optical cell. After flushing with several hundred  $\text{cm}^3$  of sea water—a flushing time of 15–20 seconds—seal the cell with the Teflon<sup>®</sup> caps ensuring that there is no headspace. Since the pH samples must be analyzed immediately, there is no long-term storage or preservation protocol. However, while awaiting analysis, store the samples in the dark at room temperature.

---

<sup>1</sup> The absorbance ratio of a concentrated dye solution can be measured using a cell with a short path length (0.5 mm).

## 7. Procedure

### 7.1 Warm sample cell to 25.0°C ( $\pm 0.1^\circ\text{C}$ )

This is done by placing a number of cells in a thermostated compartment (see section 4.6) for a few hours.

### 7.2 Measure absorbances for the cell + sea water

Clean and dry the exterior of the cell; place the cell in the thermostated sample compartment of the spectrophotometer. Measure and record the absorbances at three wavelengths: a non-absorbing wavelength (730 nm for *m*-cresol purple) and at the wavelengths corresponding to the absorption maxima of the base ( $\text{I}^{2-}$ ) and acid ( $\text{HI}^-$ ) forms of the dye respectively (578 and 434 nm).

### 7.3 Inject dye into cell

Remove one of the cell caps, add approximately  $0.05\text{--}0.1\text{ cm}^3$  of concentrated dye ( $\sim 2\text{ mmol dm}^{-3}$ ) to the sample, replace the cap and shake the cell to mix the sea water and dye. The amount of dye required is that which will produce absorbance values of between 0.4 and 1.0 at each of the two absorbance peaks.

### 7.4 Measure absorbances of cell + sea water + dye

Return the cell to the spectrophotometer and again measure the absorbances at the three wavelengths used in section 7.2. Cells should be positioned to maintain consistent alignment(s) between baseline and indicator absorbance measurements.

## 8. Calculation and expression of results

### 8.1 Correction of measured absorbances

At each of the three wavelengths, subtract the absorbances measured for the background measurement (without dye) from the corresponding absorbances measured for the system containing dye.

In addition, the absorbance measured at a non-absorbing wavelength is used to monitor and correct for any baseline shift due to error in repositioning the cell, instrumental shifts, *etc.*<sup>2</sup>. This assumes that the magnitude of any observed baseline shift is identical across the visible spectrum. To do this, subtract the measured shift from the background-corrected absorbances at wavelengths 1 and 2 to obtain the final corrected absorbance value at each wavelength.

These final absorbance values, corrected for background absorbances *and* any observed baseline shifts, are used to calculate  $A_1/A_2$ , the absorbance ratio which describes the extent of protonation of the dye.

---

<sup>2</sup> The difference between the baseline absorbance (sea water only) and the absorbance of the sample + dye at 730 nm should be no greater than  $\pm 0.001$ ; if this value is exceeded, the cell should be removed and the optical windows cleaned before the absorbances are measured again.



## 8.2 Calculation of the pH of the sea water + dye

The pH of the sea water and dye in the cell is computed from

$$\text{pH} = \text{p}K_2 + \log_{10} \left( \frac{A_1 / A_2 - \varepsilon_1(\text{HI}^-) / \varepsilon_2(\text{HI}^-)}{\varepsilon_1(\text{I}^{2-}) / \varepsilon_2(\text{HI}^-) - (A_1 / A_2) \varepsilon_2(\text{I}^{2-}) / \varepsilon_2(\text{HI}^-)} \right) \quad (7)$$

where  $\text{p}K_2$  is the acid dissociation constant for the species  $\text{HI}^-$  (expressed on the total hydrogen ion concentration scale in  $\text{mol kg-soln}^{-1}$ ), and  $A_1$  and  $A_2$  are the corrected absorbances measured at the wavelengths corresponding to the absorbance maxima of the base and acid forms, respectively. The various extinction coefficient terms  $\varepsilon$  correspond to values measured for the specified species at wavelengths 1 and 2, respectively (Table 1).

**Table 1** Extinction coefficient ratios for *m*-cresol purple.

$\varepsilon_1(\text{HI}^-) / \varepsilon_2(\text{HI}^-)$	0.00691
$\varepsilon_1(\text{I}^{2-}) / \varepsilon_2(\text{HI}^-)$	2.2220
$\varepsilon_2(\text{I}^{2-}) / \varepsilon_2(\text{HI}^-)$	0.1331

$\lambda_1 = 578 \text{ nm}$ ;  $\lambda_2 = 434 \text{ nm}$ .

The equilibrium constant  $K_2$  is a function of salinity and temperature and has been determined by careful laboratory measurements<sup>3</sup>. For *m*-cresol purple,

$$\text{p}K_2 = \frac{1245.69}{(T / \text{K})} + 3.8275 + 0.00211(35 - S) \quad (8)$$

where  $293 \leq T/\text{K} \leq 303$  and  $30 \leq S \leq 37$ .

## 8.3 Correction for pH change resulting from addition of the dye

The addition of indicator dye to the sea water sample will perturb the pH (another acid–base system has been added!). Although care is taken to minimize this (by adjusting the dye solution pH), it is desirable to correct for the addition of dye to obtain the best pH measurements.

Although, in principle, the pH perturbation could be calculated from a knowledge of the equilibrium chemistry of the sample and the dye, it is simpler to evaluate the magnitude of the correction empirically. A pair of additions of dye is made to each of a series of sea water samples with different pHs, and the change in the measured ratio ( $A_1/A_2$ ) with the second addition of indicator solution is determined as a function of the measured value ( $A_1/A_2$ ) determined after the first addition of dye using a least-squares procedure (SOP 23):

$$\frac{\Delta(A_1 / A_2)}{V} = a + b(A_1 / A_2) \quad (9)$$

<sup>3</sup> Although DelValls and Dickson (1998) have suggested that this  $\text{p}K_2$  may be in error because of an error in calibrating TRIS buffer, it seems that there may be a compensating error that largely mitigates the proposed correction. The  $\text{p}K_2$  given here is that from Clayton and Byrne (1993).

where  $V$  is the volume of dye added at each addition. The final, corrected, absorbance ratio is

$$(A_1 / A_2)_{\text{corr}} = (A_1 / A_2) - V[a + b(A_1 / A_2)]. \quad (10)$$

#### 8.4 Example calculation

$$\begin{aligned} t &= 25^\circ\text{C}, \\ S &= 35, \\ \text{p}K_2 &= 8.0056, \end{aligned}$$

and for indicator stock solution with  $A_1/A_2 = 1.6$ ,

$$\frac{\Delta(A_1 / A_2)}{V} = 0.125 - 0.147(A_1 / A_2) ..$$

*Measured absorbances:*

$$\begin{aligned} \text{Sea water:} \quad & A_{434} = 0.02433 ; \quad A_{578} = 0.01936 ; \quad A_{730} = 0.08365 \\ \text{Dye + sea water:} \quad & A_{434} = 0.45123 ; \quad A_{578} = 0.84574 ; \quad A_{730} = 0.08298 \end{aligned}$$

After addition of dye,

$$A_1 / A_2 = \frac{0.84574 - 0.01936 - (0.08298 - 0.08365)}{0.45123 - 0.02433 - (0.08298 - 0.08365)} = 1.93430.$$

Corrected to zero dye addition ( $V = 0.08 \text{ cm}^3$ ),

$$\begin{aligned} (A_1 / A_2)_{\text{corr}} &= 1.93430 - 0.08[0.125 - 0.147(1.93430)] \\ &= 1.94705 \end{aligned} \quad (11)$$

and thus

$$\text{pH} = 8.0056 + \log_{10} \left( \frac{1.94705 - 0.00691}{2.2220 - 1.94705 \times 0.1331} \right) = 8.0005.$$

## 9. Quality assurance

### 9.1 For general principles of analytical quality control see Chapter 3

### 9.2 Specific applications of analytical quality control

#### 9.2.1 Spectrophotometer performance

The spectrophotometric performance of the instrument used can be confirmed using reference materials that are available from the U.S. National Institute for Standards and Technology (NIST). SRM 2034 is a holmium oxide solution in a sealed cuvette that allows the wavelength accuracy of the spectrophotometer to be determined; SRM 930d is a set of absorbance filters that allows the

absorbance measurement accuracy to be verified. Property control charts of these measurements should be maintained, and the spectrophotometer adjusted if it goes out of tolerance. (Nevertheless, the procedure detailed here is fairly insensitive to minor changes in spectrophotometer performance.)

A more important concern is that the spectrometer must have a high stability. This can be confirmed by making a series of repeated measurements on a system of constant absorbance (*e.g.*, SRM 930d or a thermostated buffer solution containing indicator dye) and computing the standard deviation at the wavelengths of interest.

### 9.2.2 Precision

A precision of better than 0.001 pH units (1 SD) is possible with care—particularly in regard to the sample handling. The results of duplicate analyses should be plotted on a range control chart (SOP 22).

### 9.2.3 Bias

The bias of spectrophotometric pH measurements depends on the accuracy with which the various extinction coefficient ratios were determined, and on the accuracy of the values assigned to the values of  $pK_2$ . A significant advantage of spectrophotometric measurements is that, if more accurate information becomes available for these parameters at a later time, the pH results obtained can be adjusted without any degradation in precision provided that the original data are retained. At present, the likely bias is estimated to be less than 0.005 pH units.

## 10. Bibliography

- Byrne, R.H. and Breland, J.A. 1989. High precision multiwavelength pH determinations in seawater using cresol red. *Deep-Sea Res.* **36**: 803–810.
- Byrne, R.H., Robert-Baldo, G., Thompson, S.W. and Chen, C.T.A. 1988. Seawater pH measurements: an at-sea comparison of spectrophotometric and potentiometric methods. *Deep-Sea Res.* **35**: 1405–1410.
- Clayton, T.D. and Byrne, R.H. 1993. Spectrophotometric seawater pH measurements: total hydrogen ion concentration scale calibration of m-cresol purple and at-sea results. *Deep-Sea Res.* **40**: 2115–2129.
- DelValls, T.A. and Dickson, A.G. 1998. The pH of buffers based on 2-amino-2-hydroxymethyl-1,3-propanediol ('tris') in synthetic sea water. *Deep-Sea Res.* **45**: 1541–1554.
- Dickson, A.G. 1993. The measurement of sea water pH. *Marine Chem.* **44**: 131–142.

# SOP 7

## Determination of dissolved organic carbon and total dissolved nitrogen in sea water

### 1. Scope and field of application

This procedure describes a method for the determination of dissolved organic carbon (DOC) and total dissolved nitrogen (TDN) in sea water, expressed as micromoles of carbon (nitrogen) per liter of sea water. The method is suitable for the assay of oceanic levels of dissolved organic carbon ( $< 400 \mu\text{mol L}^{-1}$ ) and total dissolved nitrogen ( $< 50 \mu\text{mol L}^{-1}$ ). The instrument discussed and procedure described are those specific to the instrument employed in the Hansell Laboratory at the University of Miami. Instruments produced by other manufacturers should be evaluated for suitability.

### 2. Definition

The dissolved organic carbon content of sea water is defined as:

*The concentration of carbon remaining in a sea water sample after all particulate carbon has been removed by filtration and all inorganic carbon has been removed by acidification and sparging.*

The total dissolved nitrogen content of sea water is defined as:

*The concentration of nitrogen remaining in a sea water sample after all particulate nitrogen has been removed by filtration.*

### 3. Principle

A filtered and acidified water sample is sparged with oxygen to remove inorganic carbon. The water is then injected onto a combustion column packed with platinum-coated alumina beads held at  $680^{\circ}\text{C}$ . Non-purgeable organic carbon compounds are combusted and converted to  $\text{CO}_2$ , which is detected by a non-dispersive infrared detector (NDIR). Non-purgeable dissolved nitrogen compounds are combusted and converted to  $\text{NO}$  which, when mixed with ozone, chemiluminesces for detection by a photomultiplier.

## 4. Apparatus

- Shimadzu TOC-V<sub>CSH</sub> with ASI-V auto sampler and TNM-1 Total Nitrogen detector (or equivalent).

## 5. Reagents

### 5.1 Compressed gas

Ultra High Purity (UHP 99.995%) oxygen is used as the carrier gas for the Shimadzu TOC-V<sub>CSH</sub>. High quality carrier gas is required to obtain low background levels in the detector. Oxygen is used to ensure complete combustion of all organic material.

### 5.2 Combustion column catalyst

The carrier gas passes through a column packed with 2 mm platinum-coated alumina beads (Shimadzu P/N 017-42801-01) held at 680°C.

### 5.3 Platinum gauze

Pure platinum wire gauze (52 mesh woven from 0.1 mm diameter wire) is roughly formed into cubes ( $\approx 0.5$  cm to a side) and several (3–5) are placed on top of the combustion column bed. The platinum gauze improves analytical reproducibility and retains injected salt.

### 5.4 Acidification of sample

Trace-impurity analyzed concentrated hydrochloric acid is used to acidify samples prior to analysis. Approximately 0.1% by volume of the concentrated acid is added to each sample prior to analysis to lower the pH of the sample to  $\text{pH} < 2$ . At this pH and with sparging, all inorganic carbon species are converted to  $\text{CO}_2$  and removed from the sample. Automated acidification by the TOC-V<sub>CSH</sub> is not used, as with time the blank using this acid solution increases. When the sample is acidified manually with acid freshly taken from a sealed bottle, the increase of the blank has not been observed.

## 6. Sampling

Proper sampling techniques and handling are essential to good quality data. Care must be taken to minimize contamination of the sample. Sampling from the rosette should be done using clean silicone tubing. Gloves should be worn during sampling. It is recommended that anyone sampling from the rosette prior to collection of the samples (*e.g.*, gases) also wear gloves. If that is not possible, every effort must be made not to touch the sample nipple (the path of the water stream, from Niskin to sample bottle, must be kept very clean). Grease (whether mechanical grease from ship operations or sealing grease, as employed for some gas sampling) should never be allowed to come in contact with the sample nipple.

## 6.1 Sample preparation

Prior to sampling, 60 ml High Density Polyethylene (HDPE) bottles are cleaned, first by rinsing with distilled water, followed by a 4-hour soak in 10% hydrochloric acid, and then copiously rinsed with distilled water, inverted onto a clean surface and allowed to air dry.

All tubing and the polycarbonate inline filter holder should be acid washed and rinsed with copious quantities of distilled water prior to use. Tubing should be silicone; under no circumstances should Tygon<sup>®</sup> tubing be used as it is a source of contamination.

GF/F filters should be combusted at 450°C for at least 4 hours prior to use and stored in a sealed glass container.

## 6.2 Sample collection

Whether or not a sample is filtered prior to analysis depends on the goal of the measurement. If DOC(N) is the variable of interest, then all samples must be filtered. However, the handling of water required for filtration can introduce contaminants, so in some cases filtration may be bypassed. In oligotrophic waters, for example, where particulate organic carbon concentrations may be a very small fraction of the total organic carbon, filtering may not be necessary. Since the particles are generally small and homogeneously distributed in a sample, the analysis of unfiltered water results in a good measure of total organic carbon (TOC). Likewise, samples collected at depths > 250 m may be left unfiltered as water from these depths normally has low particulate organic carbon loads (< 1  $\mu\text{mol L}^{-1}$ ).

In high productivity areas, a substantial portion of the total carbon may be present in particulate form, and many of those particles may be large and so not homogeneously and representatively assessed in the DOC analyzer. In those situations, samples collected between the surface and 250 m are filtered through a precombusted GF/F filter. For consistency when sampling in both oligotrophic and eutrophic environments as part of a study, prefiltering is recommended for all upper layer waters.

The GF/F filters are housed in a polycarbonate inline filter holder connected to the Niskin bottle sample nipple with silicone tubing, with collection of filtrate into a precleaned 60 ml HDPE bottle. HDPE sample bottles should be labeled with sample-specific information, such as the cruise designation, cast number, and Niskin bottle number. The filter holder, with filter in place, must be well flushed with sample prior to collection into the bottles. The sample bottles should be rinsed three times with sample prior to filling. Bottles should be filled to between 75 and 90%, or 45 to 55 ml into the 60 ml bottle. This volume provides room for expansion of the water on freezing. The sample bottles are then capped tightly and frozen upright.

## 7. Procedure

Water samples are collected from the rosette. Water taken from the surface to 250 m is filtered using precombusted (450°C) GF/F inline filters as they are being collected from the Niskin bottle. At depths > 250 m, the samples are collected without filtration. After collection, samples are frozen upright in 60 ml acid-cleaned HDPE bottles, and remain cold until analysis. Prior to analysis, samples are returned to room temperature and acidified to pH < 2 with concentrated hydrochloric acid. Analysis is performed using a Shimadzu TOC-V<sub>CSH</sub> Total Organic Carbon Analyzer with the TNM-1 Total Nitrogen detector.

Instrument conditions are as follows:

Combustion temperature	680°C
Carrier gas	UHP Oxygen
Carrier flow rate	150 ml min <sup>-1</sup>
Ozone generation gas	Zero Air from Whatman TOC Gas Generator
Ozone flow rate	500 ml min <sup>-1</sup>
Sample sparge time	2.0 min
Minimum number of injections	3
Maximum number of injections	5
Number of washes	2
Standard deviation maximum	0.10 ppm
CV maximum	2.0%
Injection volume	100 µl

Each detector functions independently with respect to the acceptance values above. If DOC meets the required specifications, but TDN does not, the instrument will continue making injections until either the criteria are met or the maximum number of injections has been reached. The same is true for the situation where TDN has met the criteria and the DOC has not.

The DOC system is calibrated using potassium hydrogen phthalate and the TDN system using potassium nitrate, both in Milli-Q<sup>®</sup> water. System performance is verified daily using Consensus Reference Water ([www.rsmas.miami.edu/groups/biogeochem/CRM.html](http://www.rsmas.miami.edu/groups/biogeochem/CRM.html)). This reference water is deep Sargasso Sea water (DSR) that has been acidified and sealed in 10 ml ampoules, the concentrations of which (of DOC and TDN) have been determined by the consensus of up to six expert and independent laboratories. Low Carbon Water (LCW) that has gone through the same acidification, sealing process, and consensus verification program as the DSR, and has an agreed upon carbon concentration of 1–2 µmolC L<sup>-1</sup>, is also analyzed and used to determine the instrument blank. After verifying proper operation of the TOC/TN instrument, samples are placed on an auto sampler for analysis. The run starts with a QW (Q Water) blank and a reference seawater analysis. Then six samples are analyzed, followed by another QW blank and reference sea water. This sequence is repeated until all samples for that run are analyzed. The run ends with a QW blank, reference water, and a QW blank that had not been acidified. This last blank verifies that the hydrochloric acid used to acidify the samples is not contaminated. QW blanks and reference water samples are used to evaluate

system performance during the analytical run. If a problem is detected with the blanks or reference waters, the samples are reanalyzed.

## 8. Calculation and expression of results

The Shimadzu TOC-V<sub>CSH</sub> is calibrated for carbon using a 4- to 5-point analysis of potassium hydrogen phthalate in Milli-Q<sup>®</sup> water. The instrument determines the concentration in parts per million (ppm), and the concentration of the sample in  $\mu\text{M}$  (micromolar or micromoles per liter), corrected for the instrument blank, is calculated as

$$[(\text{Sample (ppm)} - \text{LCW (ppm)}) \times 83.33] + \text{LCW value } (\mu\text{M})$$

where Sample and LCW are the concentrations determined by the TOC-V<sub>CSH</sub>, 83.33 is a conversion factor converting ppm to  $\mu\text{M}$  and LCW is the carbon concentration of the Low Carbon Water CRM. Subtracting the LCW (ppm) from the sample removes both instrument blank and carbon content of the LCW. The carbon content of the LCW is added again (final term in equation) to calculate the correct sample concentration.

For total dissolved nitrogen, the instrument is calibrated using a similar method to that used for calibrating total carbon. The standard is potassium nitrate in Milli-Q<sup>®</sup> water. Again, the instrument is calibrated in ppm and the following calculation is used:

$$\text{Sample (ppm)} \times 71.43$$

where Sample is the concentration determined by the TOC-V<sub>CSH</sub> and 71.43 is a conversion factor from ppm to  $\mu\text{M}$ . An instrument blank has not been detected for the nitrogen system. Dissolved organic nitrogen (DON) is calculated by subtracting inorganic nitrogen ( $\text{NO}_3^-$ ,  $\text{NO}_2^-$ , *etc.*) from the total dissolved nitrogen determined by the TOC-V<sub>CSH</sub>.

## 9. Quality assurance

On a daily basis, CRM is analyzed to verify system performance. If the value of the CRM does not fall within the expected range, samples are not analyzed until the expected performance has been established.

The QW blanks and reference seawater samples analyzed with the samples are used for quality assurance and quality control (QA/QC). By evaluating the performance of these reference waters, instrument drift and performance can be evaluated. If a problem is detected with either drift or performance, the samples are reanalyzed.



# SOP 11

## Gravimetric calibration of the volume of a gas loop using water

### 1. Scope and field of application

This procedure describes how to calibrate the volume of a length of stainless steel tubing coiled as a loop based on the procedures of Wilke *et al.* (1993). Typically, two loops are installed onto an 8-port chromatography valve to calibrate the coulometer used in the determination of total dissolved inorganic carbon in sea water (SOP 2). This procedure is capable of achieving a reproducibility of about 0.01% (1 relative standard deviation). A procedure is also detailed for computing the volume of the loop, in the valve assembly, at temperatures different from the calibration temperature.

### 2. Principle

The loop is weighed empty and full of water and its volume at the calibration temperature is computed from the mass of water contained. The volume at another temperature can then be calculated by allowing for the thermal expansion of the tubing.

### 3. Apparatus

- Length of 316 stainless steel tubing  $\frac{1}{8}$  inch ( $\sim 0.3$  cm) outside diameter, electropolished on the inside, and coiled as a loop. The ends of the tubing must be cut perfectly square<sup>1</sup>. Typically, two calibration loops have lengths designed to deliver a volume of pure CO<sub>2</sub> that brackets the anticipated CO<sub>2</sub> content of the sea water samples. If the sea water sample size is approximately 29 ml, then a typical carbon yield ( $S = 35$ ,  $C_T = 2000 \mu\text{mol kg}^{-1}$ ) is about 700  $\mu\text{g C}$ . Ideal nominal loop volumes would then be 1.25 and 1.75 ml yielding about 500 and 800  $\mu\text{g C}$ , respectively.
- 8-port chromatography valve (*e.g.*, 8UWP, Valco Instruments Co. Inc. (VICI<sup>®</sup>)),
- Analytical balance, capacity 300 g, sensitivity 0.1 mg,
- Constant temperature bath capable of maintaining  $25 \pm 0.1^\circ\text{C}$ ,
- 100 ml syringe and clean Teflon<sup>®</sup> tubing to connect the syringe to the loop/valve assembly,
- Helium leak detector (*e.g.*, Gow-Mac Instrument Co., Bethlehem, PA, U.S.A.) or an alternative method for ensuring a proper seal between the loops and the chromatography valve.

---

<sup>1</sup> The square ends are needed to ensure that the tubing fits properly into the valve ports.

## 4. Reagents

- Helium supply,
- Ultra-pure water (*e.g.*, distilled and then deionized) degassed by sparging with He at  $> 200 \text{ ml min}^{-1}$  for 30 minutes,
- Dry compressed N<sub>2</sub> gas,
- Methanol (analytical grade).

## 5. Procedure

- 5.1 Clean the loop and valve assembly prior to weighing. It is essential that they be scrupulously clean before the measurement and that they remain that way. Rinse the exterior of the loop and flush the interior of the loop repeatedly with deionized water, then with methanol. Dry the loop overnight by flushing with N<sub>2</sub> gas. Use gloves or tongs to handle the loop at all times to maintain cleanliness.
- 5.2 Carefully connect the loops to the ports of the chromatography valve using either Hastalloy (ZF2HC, VICI<sup>®</sup>) or gold plated (ZF2GP, VICI<sup>®</sup>) ferrules.
- 5.3 Leak test the loop/valve assembly by pressurizing the system to  $\sim 250 \text{ kPa}$  with helium and checking for leaks using the helium leak detector.
- 5.4 Place the valve along with loose port plugs (ZC2, VICI<sup>®</sup>) into an open Ziploc freezer bag and dry in a vacuum oven at  $< 95 \text{ kPa}$  at ambient temperature until a constant weight can be determined. Reseal the bag as you remove it from the oven to minimize moisture contamination.
- 5.5 Determine the dry weight by quickly removing the valve from the Ziploc and weighing on the balance. Take the average of five weights as the “dry weight” of the assembly.
- 5.6 Once the dry weight is determined, secure the ports for the second loop using the port plugs and attach the syringe and tubing to the remaining two ports.
- 5.7 Place the container of ultra-pure water and the valve assembly double bagged in Ziplocs<sup>®</sup> (valve assembly must be kept scrupulously dry) into the constant temperature bath for 1 hour until thermally equilibrated.
- 5.8 Flush and fill the loop with ultra-pure degassed water using the syringe, then manually switch the valve as smoothly and quickly as possible to isolate the fluid path. The temperature of the water should be controlled.
- 5.9 Remove the valve from the bath, disconnect tubing and flush non-isolated valve pathways with N<sub>2</sub>, flush with two 50 ml methanol rinses, then purge with N<sub>2</sub> for 30–45 minutes at  $200 \text{ ml min}^{-1}$ . Ensure that all exposed parts are dry.
- 5.10 Weigh the valve assembly five times to determine the “full weight”.
- 5.11 Remove port plugs and rinse with methanol, dry with N<sub>2</sub>, turn valve to original position and return valve and plugs to vacuum oven.

- 5.12 Weigh the dried valve assembly at ½-hour intervals until a constant weight is obtained. If the difference between the dry weight and the final weight is  $< 0.0007$  g, then the calibration result is considered valid.

## 6. Calculation and expression of results

- 6.1 The volume ( $V$ ) of water, in milliliters, is calculated by correcting the mass of water ( $M_a$ ), determined as the difference between the full weight and the dry weight, to the weight under vacuum (buoyancy correction) and dividing the result by the density ( $d$ ) of water<sup>2</sup> at 25°C:

$$V = [M_a \cdot (0.0012/d - 0.0012/8.000) + M_a] / d \quad (1)$$

where  $0.0012 \text{ g cm}^{-3}$  is the density of moist air at standard temperature and pressure and  $8.000 \text{ g cm}^{-3}$  is the density of stainless steel weights in air.

- 6.2 The thermal expansion of the tubing being used must be taken into account in order to convert the volume measured at one temperature ( $t_1$ ) to an alternate temperature ( $t_2$ ). For 316 stainless steel, the coefficient of linear expansion ( $\alpha_l$ ) is about  $1.73 \times 10^{-5} \text{ K}^{-1}$  (Weast, 1975). The coefficient of volumetric expansion,

$$\alpha_v = (1 + \alpha_l)^3 - 1 \approx 3 \cdot \alpha_l, \quad (2)$$

is used to calculate the volume at the alternate temperature,

$$V(t_2) = V(t_1)[1 + \alpha_v(t_2 - t_1)]. \quad (3)$$

## 7. Quality assurance

The following points should be noted:

- The weights for the stainless steel tubing (dry) obtained at each measurement should agree with each other to  $\pm 1$  mg. This confirms that the tubing is being cleaned and dried adequately before each weighing.
- Measurements of the volume of the stainless steel tubing made on different days should agree with each other when corrected to a standard temperature.
- The ratio of measured loop volumes from a pair of loops should agree with the ratio of the amounts of  $\text{CO}_2$  gas delivered, as determined by the coulometer.

## 8. Bibliography

- Weast, R.F. 1975. CRC Handbook of Chemistry and Physics, 56th edition, Chemical Rubber Company.
- Wilke, R.J., Wallace, D.W.R. and Johnson, K.M. 1993. Water-based, gravimetric method for the determination of gas sample loop volume. *Anal. Chem.* **65**: 2403–2406.

---

<sup>2</sup> The formula given for the water density in Chapter 5 is for air-saturated water. However, the error induced by using this formula with helium-sparged water is negligible.

# SOP 12

## Gravimetric calibration of volume delivered using water

### 1. Scope and field of application

This procedure describes how to calibrate the volume of water delivered by a volumetric pipette—or similar device such as a Knudsen style pipette, a syringe or a piston burette. This is expressed as the volume delivered at a standard temperature (20.0°C). This procedure is capable of achieving a reproducibility of better than 0.01% (1 relative standard deviation).

### 2. Principle

The mass of water delivered by the device at a measured calibration temperature is used to compute the volume of water delivered at that temperature. The volume that would be delivered at the standard temperature (20°C) can be calculated by taking account of the volumetric expansion of the dispenser. The volume of liquid delivered at any desired temperature can be calculated in a similar fashion.

### 3. Apparatus

- Analytical balance capable of weighing the quantity of water delivered with a resolution of 1 part in  $10^5$  while having sufficient capacity to weigh the water together with the glass container used to collect it,
- Clean dry glass containers with suitable closures<sup>1</sup>,
- Thermometer accurate to  $\pm 0.1^\circ\text{C}$ ,
- Timer.

### 4. Reagents

- Deionized water.

---

<sup>1</sup> If the container and water will be weighed shortly after delivery, then an ungreased ground glass stopper, or even a screw cap, is suitable. If it will be some time before the water delivered is weighed, as when samples are delivered on board ship, it is essential that the closure chosen be both air- and water-tight.

## 5. Procedure

- 5.1 Weigh the clean, dry, empty container together with the associated closure.
- 5.2 Fill the clean pipette or other apparatus being calibrated with deionized water. Allow the temperature of the pipette and water to reach an equilibrium value. Note this temperature.
- 5.3 Allow the water to drain into the pre-weighed container for a controlled time (60 seconds).
- 5.4 Close the container and reweigh it.

## 6. Calculation and expression of results

### 6.1 Volume of water delivered at the calibration temperature

Compute the weight of the water delivered from the difference between weights of the filled and empty container:

$$w(\text{H}_2\text{O}) = w(\text{filled container}) - w(\text{empty container}). \quad (1)$$

Compute the mass of water contained, correcting for air buoyancy (see SOP 21):

$$m(\text{H}_2\text{O}) = w(\text{H}_2\text{O}) \left( \frac{1 - \rho(\text{air})/\rho(\text{weights})}{1 - \rho(\text{air})/\rho(\text{sample})} \right). \quad (2)$$

The volume dispensed at the noted temperature ( $t$ ) is

$$V(t) = m(\text{H}_2\text{O})/\rho(\text{H}_2\text{O}, t). \quad (3)$$

The density of air-saturated water in the temperature range 5 to 40°C is given by the expression (Jones and Harris, 1992)

$$\begin{aligned} \rho_w / (\text{kg m}^{-3}) = & 999.84847 + 6.337563 \times 10^{-2} (t/^\circ\text{C}) \\ & - 8.523829 \times 10^{-3} (t/^\circ\text{C})^2 + 6.943248 \times 10^{-5} (t/^\circ\text{C})^3 \\ & - 3.821216 \times 10^{-7} (t/^\circ\text{C})^4 \end{aligned} \quad (4)$$

where  $t$  is the temperature on ITS 90<sup>2</sup>. To achieve an accuracy of 1 part in 10<sup>4</sup>,  $t$  must be known to within 0.5°C.

### 6.2 Volume that would be delivered at an alternate temperature

To convert the volume dispensed at one temperature ( $t_1$ ) to the volume that would be delivered at a standard or alternate temperature ( $t_2$ ), we need to take account of

<sup>2</sup> The International Practical Temperature Scale of 1968 (IPTS 68) has been superseded by the International Temperature Scale of 1990 (ITS 90). A simple equation can be used to relate the two over the oceanographic temperature range 0 to 40°C (Jones and Harris, 1992):

$$t_{90} = 0.0002 + 0.99975 t_{68}.$$

The small difference in temperature scales is typically not important to the calibration of glassware for the procedures in this Guide.

the thermal expansion of the dispenser being used. For Pyrex-like glasses (Corning 7740, Kimble KG-33, Schott Duran, Wheaton 200, *etc.*), the coefficient of linear expansion  $\alpha_l$  is  $32.5 \times 10^{-7} \text{ K}^{-1}$ ; for glasses such as Kimble KG-35,  $\alpha_l$  is about  $55 \times 10^{-7} \text{ K}^{-1}$ .

The coefficient of volumetric expansion,

$$\alpha_v = (1 + \alpha_l)^3 - 1 \approx 3\alpha_l, \quad (5)$$

is used to calculate the corrected volume at the alternate temperature,

$$V(t_2) = V(t_1)[1 + \alpha_v(t_2 - t_1)]. \quad (6)$$

This correction is negligible for all except the most precise work unless  $t_2 - t_1$  exceeds  $10^\circ\text{C}$ .

### 6.3 Example calculation

6.3.1 The following data were used for this calculation:

$$w(\text{H}_2\text{O}) = 30.0000 \text{ g},$$

$$\text{calibration temperature} = 23.0^\circ\text{C},$$

$$\rho(\text{H}_2\text{O}, 23.0^\circ\text{C}) = 0.997535 \text{ g cm}^{-3},$$

$$\alpha_l = 32.5 \times 10^{-7} \text{ K}^{-1},$$

weighing conditions:

$$\rho(\text{air}^3) = 0.0012 \text{ g cm}^{-3},$$

$$\rho(\text{weights}) = 8.0 \text{ g cm}^{-3}.$$

6.3.2 Correct weight of water to mass:

$$\begin{aligned} m(\text{H}_2\text{O}) &= 30.0000 \times \frac{1 - 0.0012/8.0}{1 - 0.0012/0.997541} \\ &= 30.0316 \text{ g}. \end{aligned}$$

6.3.3 Compute volume of water delivered at the calibration temperature of  $23.0^\circ\text{C}$ :

$$\begin{aligned} V(23.0^\circ\text{C}) &= 30.0316 / 0.997535 \\ &= 30.1058 \text{ cm}^3. \end{aligned}$$

6.3.4 Compute volume that would be dispensed at the standard temperature of  $20.0^\circ\text{C}$ , *i.e.*, the standard calibrated volume:

$$\begin{aligned} V(20.0^\circ\text{C}) &= 30.1058 [1 + 3(32.5 \times 10^{-7})(20.0 - 23.0)] \\ &= 30.105 \text{ cm}^3. \end{aligned}$$

---

<sup>3</sup> This value is appropriate to measurements of moderate accuracy made at sea level pressure (1 atm) and at normal laboratory temperatures ( $\sim 20^\circ\text{C}$ ). For a more accurate value, see SOP 21 equation (1).

**6.3.5** Compute volume that is dispensed at 25°C.

$$\begin{aligned}V(25.0^\circ\text{C}) &= 30.1049[1 + 3(32.5 \times 10^{-7})(25.0 - 20.0)] \\ &= 30.106 \text{ cm}^3.\end{aligned}$$

## **7. Quality assurance**

To ensure that the volume dispensed is in control, the amount dispensed should be measured regularly and a property control chart maintained of the volume corrected to 20°C (see SOP 22).

## **8. Bibliography**

Jones, F.E. and Harris, G.L. 1992. ITS-90 density of water formulation for volumetric standards calibration. *J. Res. Natl. Inst. Stand. Technol.* **97**: 335–340.

# SOP 13

## Gravimetric calibration of volume contained using water

### 1. Scope and field of application

This procedure describes how to calibrate the volume of solution contained by a volumetric flask or other container capable of being filled to a reproducible mark. This is expressed as the volume contained at a standard temperature (20.0°C). This procedure is capable of achieving a reproducibility of better than 0.01% (1 relative standard deviation).

### 2. Principle

The mass of water contained by the flask at a measured calibration temperature is used to compute the volume of water contained at that temperature. The volume that would be contained at the standard temperature (20°C) can be calculated by taking account of the volumetric expansion of the flask. The volume of liquid contained at any desired temperature can be calculated in a similar fashion.

### 3. Apparatus

- Analytical balance capable of weighing the quantity of water contained with a sensitivity of 1 part in  $10^5$  while having the capacity to weigh the water together with the container being calibrated,
- Thermometer accurate to  $\pm 0.1^\circ\text{C}$ .

### 4. Reagents

- Deionized water.

### 5. Procedure

- 5.1 Weigh the clean dry empty container together with the associated closure.
- 5.2 Fill the container being calibrated to the mark with deionized water, allowing the temperature of the container and contained water to reach an equilibrium value. Note this temperature.
- 5.3 Close the container and reweigh it.



## 6. Calculation and expression of results

### 6.1 Volume of the water contained at the calibration temperature

Compute the weight of the water contained from the difference between weights of the filled and empty container:

$$w(\text{H}_2\text{O}) = w(\text{filled container}) - w(\text{empty container}). \quad (1)$$

Compute the mass of water contained, correcting for air buoyancy (see SOP 21):

$$m(\text{H}_2\text{O}) = w(\text{H}_2\text{O}) \left( \frac{1 - \rho(\text{air})/\rho(\text{weights})}{1 - \rho(\text{air})/\rho(\text{sample})} \right). \quad (2)$$

The volume contained at the noted temperature ( $t$ ) is

$$V(t) = m(\text{H}_2\text{O})/\rho(\text{H}_2\text{O}, t). \quad (3)$$

The density of air-saturated water in the temperature range 5 to 40°C is given by the expression (Jones and Harris, 1992)

$$\begin{aligned} \rho_w / (\text{kg m}^{-3}) = & 999.84847 + 6.337563 \times 10^{-2} (t/^\circ\text{C}) \\ & - 8.523829 \times 10^{-3} (t/^\circ\text{C})^2 + 6.943248 \times 10^{-5} (t/^\circ\text{C})^3 \\ & - 3.821216 \times 10^{-7} (t/^\circ\text{C})^4 \end{aligned} \quad (4)$$

where  $t$  is the temperature on ITS 90<sup>1</sup>. To achieve an accuracy of 1 part in 10<sup>4</sup>,  $t$  must be known to within 0.5°C.

### 6.2 Volume that would be contained at an alternate temperature

To convert the volume contained at one temperature ( $t_1$ ) to a standard or alternate temperature ( $t_2$ ), we need to take account of the thermal expansion of the container being used. For Pyrex-like glasses (Corning 7740, Kimble KG-33, Schott Duran, Wheaton 200, *etc.*) the coefficient of linear expansion  $\alpha_l$  is  $32.5 \times 10^{-7} \text{ K}^{-1}$ ; for glasses such as Kimble KG-35,  $\alpha_l$  is about  $55 \times 10^{-7} \text{ K}^{-1}$ .

The coefficient of volumetric expansion,

$$\alpha_v = (1 + \alpha_l)^3 - 1 \approx 3\alpha_l, \quad (5)$$

is used to calculate the corrected volume at the alternate temperature,

$$V(t_2) = V(t_1)[1 + \alpha_v(t_2 - t_1)]. \quad (6)$$

This correction is negligible for all except the most precise work; unless  $t_2 - t_1$  exceeds 10°C or if plastic ware is used.

<sup>1</sup> The International Practical Temperature Scale of 1968 (IPTS 68) has been superceded by the International Temperature Scale of 1990 (ITS 90). A simple equation can be used to relate the two over the oceanographic temperature range 0 to 40°C (Jones and Harris, 1992):

$$t_{90} = 0.0002 + 0.99975 t_{68}.$$

The small difference in temperature scales is typically not important to the calibration of glassware for the procedures in this Guide.

### 6.3 Example calculation

6.3.1 The following data were used for this calculation:

$$\begin{aligned} w(\text{H}_2\text{O}) &= 996.55 \text{ g,} \\ \text{calibration temperature} &= 23.0^\circ\text{C,} \\ \rho(\text{H}_2\text{O}, 23.0^\circ\text{C}) &= 0.997535 \text{ g cm}^{-3}, \\ \alpha_l &= 32.5 \times 10^{-7} \text{ K}^{-1}, \end{aligned}$$

weighing conditions:

$$\begin{aligned} \rho(\text{air}) &= 0.0012 \text{ g cm}^{-3},^2 \\ \rho(\text{weights}) &= 8.0 \text{ g cm}^{-3}. \end{aligned}$$

6.3.2 Correct weight of water to mass:

$$\begin{aligned} m(\text{H}_2\text{O}) &= 996.55 \times \frac{1 - 0.0012/8.0}{1 - 0.0012/0.997535} \\ &= 997.60 \text{ g.} \end{aligned}$$

6.3.3 Compute volume of water contained at the calibration temperature of 23.0°C:

$$\begin{aligned} V(23.0^\circ\text{C}) &= 997.60/0.997535 \\ &= 1000.07 \text{ cm}^3. \end{aligned}$$

6.3.4 Compute volume that would be contained at the standard temperature of 20.0°C, *i.e.*, the standard calibrated volume:

$$\begin{aligned} V(20.0^\circ\text{C}) &= 1000.07 \left[ 1 + 3(32.5 \times 10^{-7})(20.0 - 23.0) \right] \\ &= 1000.04 \text{ cm}^3. \end{aligned}$$

6.3.5 Compute volume that would be contained at 25°C.

$$\begin{aligned} V(25.0^\circ\text{C}) &= 1000.04 \left[ 1 + 3(32.5 \times 10^{-7})(25.0 - 20.0) \right] \\ &= 1000.09 \text{ cm}^3. \end{aligned}$$

## 7. Quality assurance

To ensure that the volume contained is in control, the amount contained should be measured regularly and a property control chart maintained of the volume corrected to 20°C (see SOP 22).

## 8. Bibliography

Jones, F.E. and Harris, G.L. 1992. ITS-90 density of water formulation for volumetric standards calibration. *J. Res. Natl. Inst. Stand. Technol.* **97**: 335–340.

<sup>2</sup> This value is appropriate to measurements of moderate accuracy made at sea level pressure (1 atm) and at normal laboratory temperatures (~ 20°C). For a more accurate value see SOP 21, Equation (1).

# SOP 14

## Procedure for preparing sodium carbonate solutions for the calibration of coulometric $C_T$ measurements

### 1. Scope and field of application

This procedure describes the preparation of a set of aqueous sodium carbonate solutions which are to be used for the calibration of the determination of total dissolved inorganic carbon by extraction/coulometry. Such solutions provide an alternative to the use of gas loops for the calibration of this apparatus.

### 2. Principle

Six different standard solutions are prepared which contain carefully weighed amounts of pure sodium carbonate, such that the concentrations are at approximately  $500 \mu\text{mol dm}^{-3}$  intervals from  $0$ – $2500 \mu\text{mol dm}^{-3}$ . Care is taken during the preparation and use of these solutions to minimize contamination by atmospheric carbon dioxide.

### 3. Apparatus

- $6 \times 1 \text{ dm}^3$  calibrated volumetric flasks (SOP 13),
- Balance capable of weighing the sodium carbonate to  $\pm 1 \mu\text{g}$ .

### 4. Reagents

- High purity sodium carbonate,  $> 99.95\%$  (If you wish to prepare high purity sodium carbonate yourself, follow the procedure given in IUPAC, 1969.),
- Deionized water (If desired, carbon dioxide can be removed by boiling and allowing to cool in a stream of nitrogen.),
- Cylinder of  $\text{N}_2$  gas.

## 5. Procedure

### 5.1 Preparation of solutions

Dry the sodium carbonate to constant weight in an oven at 280°C for > 2 hours and store it in a desiccator over phosphorus pentoxide until it is used.

The following procedure is carried out for each solution prepared:

- Weigh out the necessary amount of salt in a small container, such as a plastic vial, which has been treated to reduce static charge (*e.g.*, with an anti-static strip).
- Flush the clean dry flask with nitrogen for 5 minutes.
- Fill the flask  $\frac{3}{4}$  full with deionized water, filling from the bottom of the flask through a piece of tubing.
- Using a funnel, transfer the sodium carbonate from the vial to the flask. Rinse the vial and the funnel into the flask to ensure quantitative transfer of the sodium carbonate into the flask.
- Adjust the volume of solution contained in the flask to the calibration mark.
- Make sure that the headspace is filled with nitrogen gas and then close the flask with a lightly greased stopper. Once it is closed, shake it gently to dissolve all the sodium carbonate and to mix the solution.

These solutions will last for at least 1 week, provided that the headspace is kept filled with nitrogen and that the flasks are resealed after each use.

### 5.2 Calculation of concentrations of solutions

First correct the weight of  $\text{Na}_2\text{CO}_3$  for air buoyancy effects (SOP 21):

$$m(\text{Na}_2\text{CO}_3) = w(\text{Na}_2\text{CO}_3) \left( \frac{1 - \rho(\text{air})/\rho(\text{weights})}{1 - \rho(\text{air})/\rho(\text{Na}_2\text{CO}_3)} \right). \quad (1)$$

Then combine this with information on the calibrated volume of the flask,  $V(\text{flask})$  (SOP 13) and on the purity of the sodium carbonate (if known):

$$\frac{c(\text{Na}_2\text{CO}_3)}{\text{mol dm}^{-3}} = \frac{m(\text{Na}_2\text{CO}_3)/\text{g}}{105.988} \cdot \frac{1}{V(\text{flask})/\text{dm}^3} \cdot \text{purity}. \quad (2)$$

### 5.3 Example calculation

$$\begin{aligned} w(\text{Na}_2\text{CO}_3) &= 0.21230 \text{ g}, \\ V(\text{flask}) &= 1.0001 \text{ dm}^3, \\ \rho(\text{weights}) &= 8.0 \text{ g cm}^{-3}, \\ \rho(\text{Na}_2\text{CO}_3) &= 2.532 \text{ g cm}^{-3}, \\ \text{purity of Na}_2\text{CO}_3 &= 99.95\%. \end{aligned}$$

Thus

$$\begin{aligned}m(\text{Na}_2\text{CO}_3) &= 0.21230 \left( \frac{1 - 0.0012/8.0}{1 - 0.0012/2.532} \right) \\ &= 0.21237 \text{ g}\end{aligned}$$

and

$$\begin{aligned}c(\text{Na}_2\text{CO}_3) &= \frac{0.21237}{105.988} \cdot \frac{1}{1.0001} \cdot 0.9995 \\ &= 2002.5 \mu\text{mol dm}^{-3}.\end{aligned}$$

## 6. Quality assurance

The set of six calibration standards are used in a linear regression procedure (SOP 23) to calibrate the extraction/coulometric system for measurement of total dissolved inorganic carbon. If the relative standard error of the slope obtained is too high ( $> 0.15\%$ ), the data should be examined to ascertain the source of error. If necessary, additional standard solutions should be prepared. Furthermore, if the value of the intercept—the background level of carbon dioxide in the deionized water—is too high ( $> 15 \mu\text{mol dm}^{-3}$ ), the solutions should be rejected and made again with freshly boiled deionized water.

## 7. Bibliography

IUPAC. 1969. Sodium carbonate and sulphamic acid as acid-base primary standards. *Pure Appl. Chem.* **18**: 445–455.

# SOP 21

## Applying air buoyancy corrections

### 1. Scope and field of application

The effect of air buoyancy is, if uncorrected, frequently the largest source of error in mass measurements. This procedure provides equations to be used to correct for the buoyant effect of air. An air buoyancy correction should be made in all high accuracy mass determinations.

### 2. Principle

The upthrust due to air buoyancy acts both on the sample being weighed and on the counter-balancing weights. If these are of different densities and hence of different volumes, it will be necessary to allow for the resulting difference in air buoyancy to obtain an accurate determination of mass.

### 3. Requirements

#### 3.1 Knowledge of the air density at the time of weighing

For the most accurate measurements, the air density is computed from a knowledge of pressure, temperature, and relative humidity. Tolerances for the various measurements are given in Table 1.

**Table 1** Tolerances for various physical parameters.

Variable	Uncertainty in computed air density	
	± 0.1%	± 1.0%
Relative humidity (%)	± 11.3%	—
Air temperature (°C)	± 0.29 K	± 2.9 K
Air pressure (kPa)	± 0.10 kPa	± 1.0 kPa

- Barometer accurate to ± 0.05 kPa,
- Thermometer accurate to ± 0.1°C,
- Hygrometer accurate to 10%.

An error of 1% in air density results in an error of approximately 1 part in  $10^5$  in the mass corrected for air buoyancy. Although meteorological variability can result in variations of up to 3% in air density, the change of pressure (and hence of air density) with altitude can be much more significant. For measurements of moderate accuracy, made at sea level and at normal laboratory temperatures, an air density of  $0.0012 \text{ g cm}^{-3}$  is often adequate.

### 3.2 Knowledge of the apparent mass scale used to calibrate the balance

There are two apparent mass scales in common use. The older one is based on the use of brass weights adjusted to a density of  $8.4 \text{ g cm}^{-3}$ , the more recent one on the use of stainless steel weights adjusted to a density<sup>1</sup> of  $8.0 \text{ g cm}^{-3}$ .

### 3.3 Knowledge of the density of the sample

The density of the sample being weighed is needed for this calculation.

## 4. Procedure

### 4.1 Computation of air density

The density of air in  $\text{g cm}^{-3}$  can be computed from measurements of pressure, temperature, and relative humidity (Jones, 1978):

$$\rho(\text{air}) = \frac{3.4848 (p - 0.0037960U \cdot e_s)}{273.15 + t} \times 10^{-3} \quad (1)$$

where

- $p$  = air pressure (kPa),
- $U$  = relative humidity (%),
- $t$  = temperature ( $^{\circ}\text{C}$ ),
- $e_s$  = saturation vapor pressure (kPa),

$$e_s = 1.7526 \times 10^8 \exp[-5315.56/(t + 273.15)]. \quad (2)$$

### 4.2 Computation of mass from weight

The mass,  $m$ , of a sample of weight,  $w$ , and density,  $\rho(\text{sample})$ , is computed from the expression

<sup>1</sup> Strictly, these densities apply only at  $20^{\circ}\text{C}$ . The conversion factor from the “apparent mass” obtained by using these values to “true” mass is defined by the expression

$$Q = \frac{\rho(\text{weights})(D_{20} - 0.0012)}{D_{20}[\rho(\text{weights}) - 0.0012]}$$

where  $D_{20}$  is the apparent mass scale to which the weights are adjusted. This factor may be considered as unity for most purposes.

$$m = w \left( \frac{1 - \rho(\text{air})/\rho(\text{weights})}{1 - \rho(\text{air})/\rho(\text{sample})} \right) \quad (3)$$

(see Annexe for the derivation).

## 5. Example calculation

The following data were used for this calculation<sup>2</sup>:

weight of sample,  $w = 100.00000$  g,  
density of sample,  $\rho(\text{sample}) = 1.0000$  g cm<sup>-3</sup>.

Weighing conditions:

$p = 101.325$  kPa (1 atm),  
 $U = 30.0\%$ ,  
 $t = 20.00^\circ\text{C}$ ,  
 $\rho(\text{weights}) = 8.0000$  g cm<sup>-3</sup>.

### 5.1 Computation of air density

$e_s = 2.338$  kPa,  
 $\rho(\text{air}) = 0.0012013$  g cm<sup>-3</sup>.

### 5.2 Computation of mass

$m = 100.10524$  g.

## 6. Bibliography

- Dean, J.A. 1985. Lange's Handbook of Chemistry. McGraw-Hill Book Company, New York, 1792 pp.
- Jones, F.E. 1978. The air density equation and the transfer of the mass unit. *J. Res. Natl. Bureau Stand.* **83**: 419–428.
- Schoonover, R.M. and Jones, F.E. 1981. Air buoyancy correction in high-accuracy weighing on analytical balances. *Anal. Chem.* **53**: 900–902.
- Taylor, J.K. and Oppermann, H.V. 1986. Handbook for the quality assurance of metrological measurements. National Bureau of Standards Handbook 145.
- Woodward, C. and Redman, H.N. 1973. High-precision Titrimetry. The Society for Analytical Chemistry, London, 63 pp.

---

<sup>2</sup> The seemingly excessive number of decimal places is provided here so that users of this procedure can check their computation scheme.



## Annexe

### Derivation of the expression for buoyancy correction

An expression for the buoyancy correction can be derived from a consideration of the forces shown in Figure 1. Although the majority of balances nowadays are single-pan, the principles remain the same, the difference being that the forces are compared sequentially using a force sensor rather than simultaneously using a lever. At balance, the opposing forces are equal:

$$m_1 g - V_1 \rho(\text{air}) g = m_2 g - V_2 \rho(\text{air}) g \quad (4)$$

where  $g$  is the acceleration due to gravity and  $\rho(\text{air})$  is the density of the air at the temperature, pressure, and humidity of the weighing operation. Note that  $m_2$  is the “weight” of a sample whose true mass is  $m_1$ .

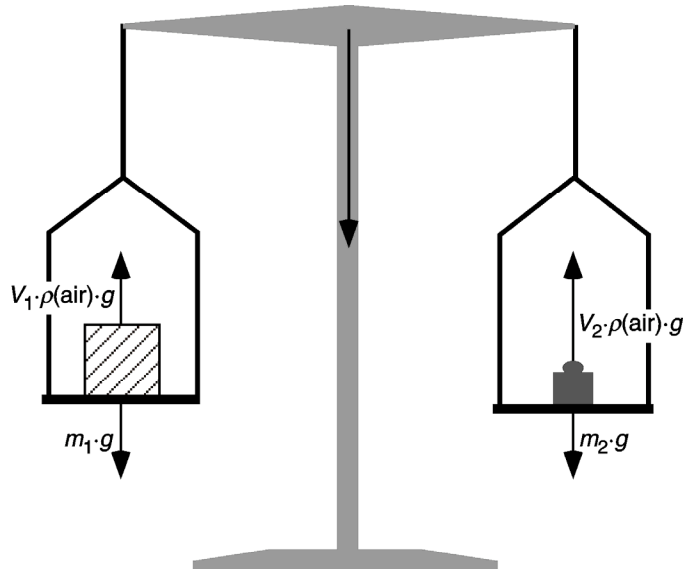

**Fig. 1** Forces on sample (1) and weights (2) when weighing in air.

As

$$V = m / \rho, \quad (5)$$

we can rewrite equation (4) as

$$m_1 - m_1 \rho(\text{air}) / \rho_1 = m_2 - m_2 \rho(\text{air}) / \rho_2. \quad (6)$$

This equation can be rearranged to obtain the expression

$$m_1 = m_2 \frac{1 - \rho(\text{air})/\rho_2}{1 - \rho(\text{air})/\rho_1}. \quad (7)$$

Equation (7) is the basis of the expression used for air buoyancy correction (Schoonover and Jones, 1981; Taylor and Oppermann, 1986):

$$m = w \frac{1 - \rho(\text{air})/\rho(\text{weights})}{1 - \rho(\text{air})/\rho(\text{sample})} \quad (8)$$

where  $w$  is the “weight” of the sample in air and  $m$  is the true mass.

Equation (6) can also be rearranged to give

$$m_1 = m_2 + m_2 \rho(\text{air}) \left( \frac{m_1}{m_2} \frac{1}{\rho_1} - \frac{1}{\rho_2} \right). \quad (9)$$

As  $m_1 \approx m_2$ , equation (9) is almost identical to the commonly quoted expression for buoyancy correction,

$$m = w + w \rho(\text{air}) \left[ \frac{1}{\rho(\text{sample})} - \frac{1}{\rho(\text{weights})} \right] \quad (10)$$

(Woodward and Redman, 1973; Dean, 1985). An approximate value of  $0.0012 \text{ g cm}^{-3}$  for  $\rho(\text{air})$  is often used with this expression; this is appropriate to measurements of moderate accuracy made at sea level pressures and at normal laboratory temperatures.

# SOP 22

## Preparation of control charts

### 1. Scope and field of application

This procedure details the preparation and use of property ( $\bar{X}$ ) and range ( $R$ ) control charts. The  $\bar{X}$  chart is used to demonstrate whether a measurement mean is in control; the  $R$  chart is used to demonstrate whether measurement variability is in control. Such charts are basic tools for the quality assurance of analytical measurements. They can be used to document measurement uncertainty and to monitor a variety of aspects of a measurement process, such as blank levels or instrument sensitivity.

### 2. Principle

The construction of a control chart is based on statistical principles, specifically on the normal distribution. The control limits are based on considerations of probability; thus decisions that a system is in control are supported. Similarly, the control limits can be used to warn of potential problems and reveal the need for corrective action. Control charts should be kept in real time so that such corrective action is taken promptly.

### 3. Procedure

#### 3.1 Statistical calculations

SOP 23 of this Guide provides all the necessary information to carry out the statistical calculations needed in this SOP.

#### 3.2 The $\bar{X}$ chart

Values obtained for repetitive measurements of a control sample are plotted sequentially to evaluate the stability of the measurement process (see Figure 1). Such control samples must be very similar to the test samples of interest, otherwise it is not possible to draw conclusions about the performance of the system on test samples from this information.

The results from at least 12 measurements—with never more than one measurement made on the same day—are used to compute estimates of the mean and standard deviation of the data in accordance with the standard expressions (SOP 23).

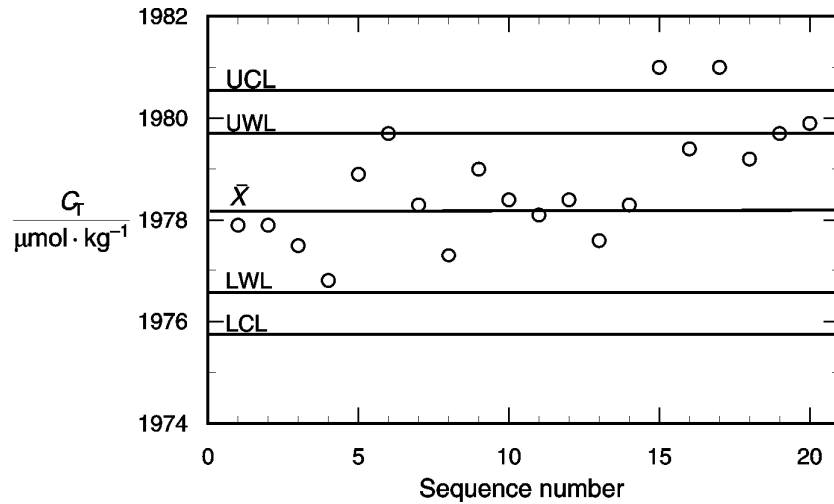

**Fig. 1** Example of a property control chart showing a trend in the data with time; control limits were calculated from the first 12 points. This chart indicates that the measurement process is not in control.

The central line is the mean value,  $\bar{x}$ , the control limits are based on the sample standard deviation,  $s$ :

$$\begin{aligned}
 \text{upper control limit} & \quad \text{UCL} = \bar{x} + 3s, \\
 \text{upper warning limit} & \quad \text{UWL} = \bar{x} + 2s, \\
 \text{lower warning limit} & \quad \text{LWL} = \bar{x} - 2s, \\
 \text{lower control limit} & \quad \text{LCL} = \bar{x} - 3s.
 \end{aligned}$$

When so set, approximately 95% of the plotted points should fall between the warning limits (UWL and LWL) and rarely should any fall outside the control limits (UCL and LCL).

### 3.3 The R chart

The absolute differences ( $R$ ) of duplicate measurements are plotted sequentially to evaluate the precision of the measurement process (see Figure 2). The average range  $\bar{R}$  is related to the short-term standard deviation (or repeatability,  $s_R$ ) of the measurement process (SOP 23). At least 12 measurements should be used to compute  $\bar{R}$ . The control limits for duplicate measurements are:

$$\begin{aligned}
 \text{UCL} & = 3.267 \bar{R}, \\
 \text{UWL} & = 2.512 \bar{R}, \\
 \text{LWL} & = 0, \\
 \text{LCL} & = 0.
 \end{aligned}$$

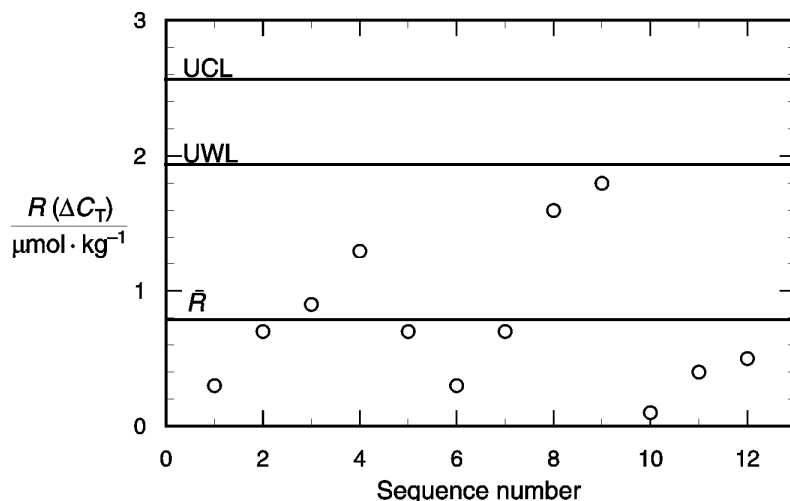

**Fig. 2** Example of a range control chart; control limits were calculated using all the data shown. The measurement precision is in control.

### 3.4 Updating control charts

After additional control data have been accumulated—at least as much as was used originally—the control limits may be updated. A  $t$  test is made to assess whether  $\bar{x}$  for the second set of data is significantly different from that for the first (SOP 23). If not, all the data may be used to compute a new estimate of  $\bar{x}$ , otherwise only the second set of data should be used to revise the control chart.

The value of the sample standard deviation,  $s$ , should also be calculated for the second set of data. It should be compared with the estimate from the first set of data, using the  $F$  test (SOP 23) to decide whether to pool it with the first, or use it separately in setting new control limits.

If the values of  $R$  show no significant trends and if  $\bar{R}$  has not changed significantly, all of the values of  $R$  should be combined to obtain an updated estimate of  $\bar{R}$  from which updated control limits can be computed. Judgement of the significance of changes in  $\bar{R}$  is best decided by computing the corresponding values of the short-term standard deviation (the repeatability) and conducting an  $F$  test.

### 3.5 Interpretation of control chart data

Points plotted on a control chart should be randomly distributed within the warning limits when the system is in a state of statistical control. If a plotted point lies outside of the warning limits, a second set of measurements should be made. If this point also lies outside the warning limits, corrective action is required and demonstrated attainment of control is necessary before measurements may be reported with confidence. Barring blunders, one point outside of the control limits is reason for corrective action. The nature of the corrective action to be taken will depend, in either case, on the kind of measurement made. If the  $X$  point is outside the limits but the  $R$  point is not, a source of bias should be sought and eliminated. If the  $R$  point is outside of limits,  $X$  probably will be as well. Sources of

extraordinary random error should be sought and eliminated before any possible bias can be detected.

Control charts may be used to evaluate the uncertainty of measurement in some cases. When an appropriate control chart is maintained, a  $\bar{X}$  chart may be used to evaluate bias and to document the standard deviation of the measurement process. Then the values of  $s$  on which the control limits are based may be used in calculating confidence limits for measurement values.

#### 4. Bibliography

- Kateman, G. and Buydens, L. 1993. Quality Control in Analytical Chemistry, 2nd edition, Wiley-Interscience, New York, 317 pp.
- Ryan, T.P. 1989. Statistical Methods for Quality Improvement. John Wiley & Sons, Inc., New York, 446 pp.
- Taylor, J.K. and Oppermann, H.V. 1986. Handbook for the quality assurance of metrological measurements. National Bureau of Standards. NBS Handbook 145.
- Taylor, J.K. 1987. Quality Assurance of Chemical Measurements, Lewis Publishers, Inc., Chelsea, 328 pp.
- Taylor, J.K. 1990. Statistical Techniques for Data Analysis. Lewis Publishers, Inc., Chelsea, 200 pp.

# SOP 23

## Statistical techniques used in quality assessment

### 1. Scope and field of application

This procedure describes various statistical calculations used in quality assessment. Calculations are detailed which allow the computation of the mean and standard deviation of a set of values, the computation of a standard deviation from a set of duplicate measurements, the computation of the confidence interval for a mean, the examination of the values of two means or of two standard deviations to assess if they are significantly different at some chosen level of probability, and the computation of the least-squares estimates of the slope and intercept of a straight line.

### 2. Principle

These calculations are based on statistical principles, specifically on the normal distribution. More details of the relevant statistical background are given in the bibliography.

### 3. Procedure

#### 3.1 Estimation of the mean and standard deviation from a series of measurements

Given  $n$  measurements,

$$x_1, x_2, x_3, \dots, x_n,$$

the mean,  $\bar{x}$ , is given by

$$\bar{x} = \frac{1}{n} \sum_{i=1}^n x_i \quad (1)$$

and an estimate of the standard deviation,  $s$ , is given by

$$s = \left( \frac{\sum_{i=1}^n (x_i - \bar{x})^2}{n-1} \right)^{1/2}. \quad (2)$$

### 3.2 Estimation of the standard deviation from the difference of sets of duplicate measurements

Given  $k$  differences of duplicate measurements,

$$d_1, d_2, d_3, \dots, d_k,$$

an estimate of the standard deviation,  $s$ , is given by

$$s_R = \left( \frac{\sum_{i=1}^k d_i^2}{2k} \right)^{1/2}. \quad (3)$$

This is a measure of the short-term standard deviation, or repeatability of measurements<sup>1</sup>.

### 3.3 Confidence interval for a mean

The formula for use is

$$\bar{x} \pm \frac{ts}{\sqrt{n}} \quad (4)$$

where

$\bar{x}$  = sample mean,

$n$  = number of measurements on which the mean is based,

$s$  = estimate of the standard deviation<sup>2</sup>,

$t$  = Student's  $t$  value, *i.e.*, the probability factor for the desired confidence limit and the number of degrees of freedom associated with  $s$ . (For numerical values, see Table 1 in the Annexe to this procedure.)

### 3.4 Comparing values of two means

*Case 1.* No reason to believe that the standard deviations differ.

Step 1: Choose  $\alpha$ , the desired probability level (*i.e.*, the significance level) of the test.

Step 2: Calculate a pooled standard deviation from the two estimates to obtain a better estimate of the standard deviation:

<sup>1</sup> The International Organization for Standardization (ISO) applies two descriptions of precision: (1) the *reproducibility*, the closeness of agreement between individual results obtained with the same method but under different conditions (*e.g.*, in different laboratories) and (2) the *repeatability*, the closeness of agreement between successive results obtained with the same method and under the same conditions.

<sup>2</sup> If  $\bar{x}$  and  $s$  are based on the same data set, the number of degrees of freedom,  $df = n - 1$ . However, if  $s$  is based on additional evidence, such as a system under statistical control (judged by a control chart), then the degrees of freedom on which the estimate of  $s$  is based may be used to determine  $t$ . In such a case, one can calculate a confidence interval for even a single measurement.



$$s_p = \left( \frac{\nu_A s_A^2 + \nu_B s_B^2}{\nu_A + \nu_B} \right)^{1/2} \quad (5)$$

where  $\nu_A$  and  $\nu_B$  are the number of degrees of freedom associated with  $s_A$  and  $s_B$ , respectively.  $s_p$  will thus be based on  $\nu_A + \nu_B$  degrees of freedom.

Step 3: Calculate the uncertainty,  $U$ , of the differences

$$U = t s_p \left( \frac{1}{n_A} + \frac{1}{n_B} \right)^{1/2} \quad (6)$$

where  $t$  is the appropriate Student's  $t$  value.

Step 4: Compare  $\Delta = |\bar{x}_A - \bar{x}_B|$  with  $U$ . If  $\Delta \leq U$ , there is no reason to believe that the means disagree.

*Case 2.* The standard deviations differ significantly (see section 3.5).

Step 1: Choose  $\alpha$ , the significance level of the test.

Step 2: Compute the estimated variance of each mean using the individual estimates of the standard deviations,

$$V_A = s_A^2/n_A, \quad V_B = s_B^2/n_B. \quad (7)$$

Step 3: Compute the effective number of degrees of freedom<sup>3</sup>:

$$f^* = \frac{(V_A + V_B)^2}{\frac{V_A^2}{n_A + 1} + \frac{V_B^2}{n_B + 1}} - 2. \quad (8)$$

Step 4: Calculate the uncertainty,  $U$ , of the differences

$$U = t^* \sqrt{V_A + V_B} \quad (9)$$

where  $t^*$  is the effective value of  $t$  based on  $f^*$  degrees of freedom and the chosen significance level,  $\alpha$  (Table 1 in the Annexe).

Step 5: Compare  $\Delta = |\bar{x}_A - \bar{x}_B|$  with  $U$ . If  $\Delta \leq U$ , there is no reason to believe that the means disagree.

### 3.5 Comparing estimates of a standard deviation ( $F$ test)

This test may be used to decide whether there is sufficient reason to believe that two estimates of a standard deviation are significantly different. It consists of

<sup>3</sup> A number of expressions exist in the literature for this calculation, with some authors even arguing that such a pooling of the variances is inappropriate. The expression used here comes from Taylor (1987).

calculating the ratio of the variances and comparing it with tabulated values. Unless the computed ratio is larger than the tabulated value, there is no reason to believe that the respective standard deviations are significantly different.

The  $F$  ratio is calculated as

$$F = \frac{s_L^2}{s_S^2} \quad (10)$$

where  $s_L$  is the larger value and  $s_S$  is the smaller of the two estimates under consideration. The critical value of  $F$  will depend on the significance level chosen and on the degrees of freedom associated with  $s_L$  and  $s_S$  (see Table 2 in the Annexe).

### 3.6 Computation of least-squares estimates

For the linear model,

$$y_i = \beta_0 + \beta_1 x_i + \varepsilon_i \quad (11)$$

where  $x$  is essentially without error (for data with errors in  $x$  and  $y$ —see York, 1966) and the error  $\varepsilon_i$  is normally distributed with a constant variance, least-squares estimates of the coefficients,  $\beta_0$  and  $\beta_1$ , are given by the expressions

$$\beta_1 = \frac{\sum_i (x_i - \bar{x})(y_i - \bar{y})}{\sum_i (x_i - \bar{x})^2}, \quad (12)$$

$$\beta_0 = \bar{y} - \beta_1 \bar{x}. \quad (13)$$

An estimate of the experimental error variance is then given by

$$s^2 = \frac{\sum_i (y_i - \beta_0 - \beta_1 x_i)^2}{n - 2} \quad (14)$$

and estimates of the standard errors of the coefficients by

$$\text{S.E.}(\beta_0) = s \left( \frac{1}{n} + \frac{\bar{x}^2}{\sum_i (x_i - \bar{x})^2} \right)^{1/2}, \quad (15)$$

$$\text{S.E.}(\beta_1) = \frac{s}{\left( \sum_i (x_i - \bar{x})^2 \right)^{1/2}}. \quad (16)$$

## 4. Example calculations

### 4.1 Estimation of the mean and standard deviation from a series of measurements

Given the following 9 measurements:

1977.67, 1977.98, 1977.29, 1978.60, 1979.48,  
1979.14, 1979.33, 1979.95, 1979.99,

the mean is 1978.83 and the standard deviation is 0.99.

### 4.2 Estimation of the standard deviation from the difference of sets of duplicate measurements

Given 10 pairs of measurements:

1976.8, 1979.3, 1978.9, 1979.6, 1979.6, 1979.8  
1978.3, 1978.6, 1981.2, 1979.8, 1977.6, 1977.8  
1976.2, 1976.8, 1978.6, 1977.0, 1976.6, 1978.9  
1978.3, 1978.9,

the standard deviation calculated using

$$s_R = \left( \frac{\sum_{i=1} d_i^2}{2k} \right)^{1/2}$$

is 0.93.

### 4.3 Confidence interval for a mean

The 95% confidence interval for the mean calculated in section 4.1 is

$$1978.83 \pm \frac{(2.306)(0.99)}{\sqrt{9}} = 1978.83 \pm 0.76$$

### 4.4 Comparing values for two means

*Case 1.* No reason to believe that the standard deviations differ.

$$\begin{aligned} \bar{x}_A &= 1978.78, & s_A &= 0.93, & n_A &= 9 \\ \bar{x}_B &= 1981.74, & s_B &= 0.87, & n_B &= 18 \end{aligned}$$

Step 1: Require 95% confidence in decision.

Step 2: Pooled standard deviation:

$$s_p = \left( \frac{8(0.93)^2 + 17(0.87)^2}{8 + 17} \right)^{1/2}$$

$$= 0.89.$$

Step 3: Calculate  $U$ :

$$U = 2.060(0.89) \left( \frac{1}{9} + \frac{1}{18} \right)^{1/2}$$

$$= 0.75.$$

Step 4: As  $\Delta$  ( $= 1981.74 - 1978.78 = 2.96$ ) is larger than  $U$ , the means disagree at the 95% confidence level.

*Case 2.* The standard deviations differ significantly.

$$\bar{x}_A = 1978.78, \quad s_A = 0.93, \quad n_A = 9$$

$$\bar{x}_B = 1981.74, \quad s_B = 2.75, \quad n_B = 16$$

Step 1: Require 95% confidence in decision.

Step 2: Compute the estimated variance of each mean:

$$V_A = (0.93)^2 / 9 = 0.0961$$

$$V_B = (2.75)^2 / 16 = 0.4727.$$

Step 3: Compute the effective number of degrees of freedom:

$$f^* = \left[ \frac{(0.0961 + 0.4727)^2}{(0.0961)^2 / (9 + 1) + (0.4727)^2 / (16 + 1)} \right] - 2 \approx 21.$$

Step 4: Calculate  $U$ :

$$U = 2.08(0.0961 + 0.4727)^{1/2} = 1.57.$$

Step 5: As  $\Delta$  ( $= 1981.74 - 1978.78 = 2.96$ ) is larger than  $U$ , the means disagree at the 95% confidence level.

#### 4.5 Comparing estimates of a standard deviation

$$\bar{x}_A = 1978.78, \quad s_A = 0.93, \quad n_A = 9$$

$$\bar{x}_B = 1975.35, \quad s_B = 1.71, \quad n_B = 12$$

Calculate  $F$ :

$$F = \frac{(1.71)^2}{(0.93)^2} = 3.38.$$

The tabulated value of  $F$ —with 8 degrees of freedom in the numerator and 11 degrees of freedom in the denominator—is 3.7. As the computed value is smaller than the tabulated value, there is no reason to believe that the two standard deviations are significantly different.

## 4.6 Computation of least-squares estimates

Given 6 pairs of measurements of  $x$  and  $y$ :

0.0	1892
498.8	66537
1001.9	130818
1500.8	195216
2002.5	260068
2497.1	323456

Linear regression gives

$$\begin{aligned}\beta_0 &= 2017.77, \\ \beta_1 &= 128.765.\end{aligned}$$

The error estimates are

$$\begin{aligned}s &= 221.77, \\ \text{S.E.}(\beta_0) &= 160.55, \\ \text{S.E.}(\beta_1) &= 0.106.\end{aligned}$$

## 5. Bibliography

- Box, G.E.P., Hunter, W.G. and Hunter, J.S. 1978. *Statistics for Experimenters. An Introduction to Design, Data Analysis, and Model Building*. John Wiley & Sons, 653 pp.
- Meier, P.C. and Zünd, R.E. 1993. *Statistical Methods in Analytical Chemistry*. Wiley Interscience, New York, 321 pp.
- Ryan, T.P. 1989. *Statistical Methods for Quality Improvement*. John Wiley & Sons, Inc., New York, 446 pp.
- Taylor, J.K. 1987. *Quality Assurance of Chemical Measurements*. Lewis Publishers, Inc., Chelsea, 328 pp.
- Taylor, J.K. 1990. *Statistical Techniques for Data Analysis*. Lewis Publishers, Inc., Chelsea, 200 pp.
- York, D. 1966. Least-squares fitting of a straight line. *Can. J. Physics* **44**: 1079–1086.

## Annexe

**Table 1** Student's  $t$  values for 95% and 99% confidence intervals.

Probability level for two-sided confidence interval		
df <sup>4</sup>	95%	99%
1	12.706	63.657
2	4.303	9.925
3	3.182	5.841
4	2.776	4.604
5	2.571	4.032
6	2.447	3.707
7	2.365	3.499
8	2.306	3.355
9	2.262	3.250
10	2.228	3.169
11	2.201	3.106
12	2.179	3.055
13	2.160	3.012
14	2.145	2.977
15	2.131	2.947
16	2.120	2.921
17	2.110	2.898
18	2.101	2.878
19	2.093	2.861
20	2.086	2.845
25	2.060	2.787
40	2.021	2.704
60	2.000	2.660
$\infty$	1.960	2.576

<sup>4</sup> degrees of freedom ( $n - 1$ )

**Table 2** Critical values for the  $F$  test for use in a two-tailed test of equality of standard deviation at 95% level of confidence.

$df_D$	$df_N$									
	1	2	4	6	8	10	15	20	30	40
1	648	800	900	937	957	969	983	993	1001	1006
2	38.5	39.0	39.2	39.3	39.4	39.4	39.4	39.4	39.5	39.5
4	12.2	10.6	9.6	9.2	9.0	8.8	8.7	8.6	8.5	8.4
6	8.8	7.3	6.2	5.8	5.6	5.5	5.3	5.2	5.1	5.0
8	7.6	6.1	5.0	4.6	4.4	4.3	4.1	4.0	3.9	3.8
10	6.9	5.5	4.5	4.1	3.8	3.7	3.5	3.4	3.3	3.3
15	6.2	4.8	3.8	3.4	3.2	3.1	2.9	2.8	2.6	2.6
20	5.9	4.5	3.5	3.1	2.9	2.8	2.6	2.5	2.4	2.3
30	5.6	4.2	3.2	2.9	2.6	2.5	2.3	2.2	2.1	2.0
40	5.4	4.0	3.1	2.7	2.5	2.4	2.2	2.1	1.9	1.9
60	5.3	3.9	3.0	2.6	2.4	2.3	2.1	1.9	1.8	1.7
120	5.2	3.8	2.9	2.5	2.3	2.2	1.9	1.8	1.7	1.6
$\infty$	5.0	3.7	2.8	2.4	2.2	2.1	1.8	1.7	1.6	1.5

$df_D$  — degrees of freedom of the variance in the denominator.

$df_N$  — degrees of freedom of the variance in the numerator.

# SOP 24

## Calculation of the fugacity of carbon dioxide in pure carbon dioxide gas or in air

### 1. Scope and field of application

This procedure describes a method for the calculation of the fugacity of carbon dioxide in pure carbon dioxide gas or in air. The fugacity,  $f(\text{CO}_2)$ , is expressed either in Pascals or in atmospheres<sup>1</sup>.

### 2. Definition

The chemical potential ( $\mu_B$ ) of an individual component of a vapor phase can be expressed in terms of its fugacity ( $f_B$ ). This is defined by the equation

$$RT \ln f_B = \mu_B - \lim_{p \rightarrow 0} [\mu_B - RT \ln(x_B p / p^\circ)] \quad (1)$$

where  $x_B$  is the mole fraction of B in the gaseous mixture and thus  $x_B p$  is the partial pressure of B ( $p_B$ ) in the vapor phase and  $p^\circ$  is a standard pressure (typically 101325 Pa, *i.e.*, 1 atm). The term

$$\lim_{p \rightarrow 0} [\mu_B - RT \ln(x_B p / p^\circ)] \quad (2)$$

is thus a standard chemical potential,  $\mu_B^\circ(T)$ .

### 3. Principle

The vapor phase fugacity of either a pure gas ( $x_B = 1$ ) or of a component in a mixture of gases can be calculated from the equation

$$f_B = x_B p \exp\left(\frac{1}{RT} \int_0^p (V_B - RT/p') dp'\right). \quad (3)$$

---

<sup>1</sup> 1 atm = 101325 Pa.



$V_B$  is obtained from

$$V_B = \left( \frac{\partial V}{\partial n_B} \right)_{T,p}, \quad (4)$$

where  $V$  is given by an equation of state for the vapor,

$$V = f(T, p). \quad (5)$$

### 3.1 The ideal gas equation

The simplest equation of state is the expression for a perfect gas mixture,

$$V = \frac{RT}{p} \sum_B n_B. \quad (6)$$

The integral in equation (3) is then equal to zero and

$$f_B = x_B p. \quad (7)$$

### 3.2 The virial equation

More generally, the equation of state can be represented by a virial expression,

$$\frac{pV_B}{RT} = 1 + \frac{B(T)}{V_B} + \frac{C(T)}{V_B^2} + \dots \quad (8)$$

This equation, truncated after the second virial coefficient, is usually adequate to represent  $p$ - $V$ - $T$  properties at pressures up to a few atmospheres. It also has the advantage that the coefficient,  $B(T)$ , can be related to the intermolecular potential energy function of the molecules concerned.

In a mixture of gases,

$$B(T) = \sum_l \sum_m x_l x_m B_{lm}(T) \quad (9)$$

where  $B_{lm} = B_{ml}$ . The total volume can then be written as

$$V = \sum_k n_k V_k = \sum_k n_k \frac{RT}{p} + \frac{\sum_l \sum_m n_l n_m B_{lm}(T)}{\sum_k n_k}. \quad (10)$$

The partial molar volume of an individual component is

$$V_B = \frac{RT}{p} - \frac{\sum_l \sum_m n_l n_m B_{lm}(T)}{\left( \sum_k n_k \right)^2} + \frac{2 \sum_m n_m B_{Bm}(T)}{\sum_k n_k} \quad (11)$$

and thus

$$V_B = \frac{RT}{p} + \sum_l \sum_m x_l x_m [2B_{Bm}(T) - B_{lm}(T)]p. \quad (12)$$

The fugacity is then given by

$$f_B = x_B p \exp\left(\frac{\sum_l \sum_m x_l x_m (2B_{Bm}(T) - B_{lm}(T))p}{RT}\right). \quad (13)$$

For a pure gas, this reduces to

$$f_B = p \exp\left(\frac{B_{BB}(T)p}{RT}\right) \quad (14)$$

where  $B_{BB}(T)$  is the virial coefficient for the pure gas, B.

A further particular case of equation (13) is the expression for a component of a binary mixture,

$$f_B = x_B p \exp\left[\left(B_{BB}(T) + 2x_C^2 \delta_{B-C}(T)\right) \frac{p}{RT}\right] \quad (15)$$

where

$$\delta_{B-C} = B_{BC} - \frac{1}{2}(B_{BB} + B_{CC}). \quad (16)$$

Many of the cross-virial coefficients for the practical computation of fugacity in vapor mixtures have never been measured experimentally. However, a number of empirical approaches can be used.

The simplest of these is the Lewis and Randall rule,

$$f_B = x_B f_B^* \quad (17)$$

where  $f_B^*$  is the fugacity of pure component, B, at the same temperature and total pressure as the mixture (equation 14).

An alternate method of predicting  $B(T)$ , based on statistical–mechanical arguments, is to use the expression

$$B(T) = 2\pi L \int_0^{\infty} [1 - \exp(-u(r)/kT)] r^2 dr \quad (18)$$

where  $L$  is the Avogadro constant and  $k$  the Boltzmann constant. Here,  $u(r)$ —the pair-interaction energy—is assumed to depend only on the separation,  $r$ , of the centers of mass of two molecules.

## 4. Calculation and expression of results

### 4.1 Virial coefficient of pure carbon dioxide gas

The first virial coefficient of CO<sub>2</sub>,  $B(\text{CO}_2, T)$ , is given by the expression (Weiss, 1974) which is based on values reported by Levelt Sengers *et al.* (1971):

$$\frac{B(\text{CO}_2, T)}{\text{cm}^3 \text{ mol}^{-1}} = -1636.75 + 12.0408 \left( \frac{T}{\text{K}} \right) - 3.27957 \times 10^{-2} \left( \frac{T}{\text{K}} \right)^2 + 3.16528 \times 10^{-5} \left( \frac{T}{\text{K}} \right)^3 \quad (19)$$

where  $265 < T/\text{K} < 320$ .

This expression can then be used in equation (14) to calculate the fugacity of pure CO<sub>2</sub> provided that the pressure and temperature of the CO<sub>2</sub> are known.

### 4.2 Virial coefficient of carbon dioxide in air

In addition, Weiss used the Lennard–Jones (6–12) potential to estimate  $u(r)$  and hence calculate values for  $\delta_{\text{BC}}$  for the binary mixture: CO<sub>2</sub>–air. He found that the temperature dependence of this parameter is represented by the equation

$$\frac{\delta(\text{CO}_2 - \text{air})}{\text{cm}^3 \text{ mol}^{-1}} = 57.7 - 0.118 \left( \frac{T}{\text{K}} \right) \quad (20)$$

where  $273 < T/\text{K} < 313$ .

This expression can then be used in equation (15), together with equation (19), to calculate the fugacity of CO<sub>2</sub> in air.

### 4.3 Example calculations

#### 4.3.1 Fugacity of pure CO<sub>2</sub>

$$T = 298.15 \text{ K},$$

$$p = 101.325 \text{ kPa (1 atm)}.$$

Then,

$$B(T) = -123.2 \text{ cm}^3 \text{ mol}^{-1},$$

$$f(\text{CO}_2) = 101325 \exp\left(\frac{-123.2 \times 10^{-6} \times 101325}{8.31447 \times 298.15}\right)$$

$$= 100.816 \text{ kPa}$$

or

$$f(\text{CO}_2) = 100.816 / 101.325 = 0.99498 \text{ atm}.$$

### 4.3.2 Fugacity of CO<sub>2</sub> in air

$$T = 298.15 \text{ K},$$

$$p = 101.325 \text{ kPa (1 atm)},$$

$$x(\text{CO}_2) = 350 \times 10^{-6}.$$

Then,

$$B(T) = -123.2 \text{ cm}^3 \text{ mol}^{-1},$$

$$\delta(\text{CO}_2\text{-air}) = 22.5 \text{ cm}^3 \text{ mol}^{-1},$$

$$f(\text{CO}_2) = (350 \times 10^{-6})(101325)$$

$$\times \exp \left\{ \frac{\left[ -123.2 \times 10^{-6} + 2(1 - 350 \times 10^{-6})^2 (22.5 \times 10^{-6}) \right] \times 101325}{8.31447 \times 298.15} \right\}$$

$$= 35.35 \text{ Pa (348.9} \times 10^{-6} \text{ atm)}.$$

## 5. Bibliography

- Dymond, J.H. and Smith, E.B. 1969. Virial Coefficients of Gases: A Critical Compilation. Oxford Science Research Papers **2**, Clarendon Press, Oxford.
- Guggenheim, E.A. 1967. Thermodynamics. An Advanced Treatment for Chemists and Physicists, 5th edition, North-Holland, 390 pp.
- Hirschfelder, J.O., Curtiss, C.F. and Bird, R.B. 1954. Molecular Theory of Gases and Liquids. Wiley, New York.
- IUPAC. 1988. Quantities, units and symbols in physical chemistry. Prepared by I. Mills, Blackwell Scientific Publications, Oxford.
- Levelt Sengers, J.M.H., Klein, M. and Gallagher, J.S. 1971. Pressure-volume-temperature relationships of gases: virial coefficients. USAF Arnold Engineering Development Center Technical Report. AEDC TR-71-39.
- McGlashan, M.L. 1979. Chemical Thermodynamics. Academic Press, 345 pp.
- Weiss, R.F. 1974. Carbon dioxide in water and seawater: the solubility of a non-ideal gas. *Mar. Chem.* **2**: 203–215.

# Chapter 5

## Physical and thermodynamic data

### Table of Contents

1. Values for various fundamental constants .....	3
2. Atomic weights .....	3
3. Vapor pressure of water .....	5
3.1 Pure water .....	5
3.2 Sea water .....	6
4. Densities of various substances .....	6
4.1 Air-saturated water .....	6
4.2 Sea water .....	7
4.3 Sodium chloride solutions .....	7
4.4 A mixture of NaCl and HCl at 25°C .....	8
4.5 Various solids .....	8
5. Virial coefficients for carbon dioxide .....	9
5.1 Pure carbon dioxide gas .....	9
5.2 Carbon dioxide in air .....	9
6. Salinity and the composition of sea water .....	10
6.1 The major ion composition of sea water .....	10
6.2 A simplified synthetic sea water recipe .....	11
7. Equilibrium constants .....	12
7.1 Solubility of carbon dioxide in sea water .....	12
7.2 Acid–base reactions in sea water .....	12
7.2.1 Bisulfate ion .....	12
7.2.2 Boric acid .....	13
7.2.3 Carbonic acid .....	13
7.2.4 Hydrogen fluoride .....	14
7.2.5 Phosphoric acid .....	14
7.2.6 Silicic acid .....	16
7.2.7 Water .....	16
7.3 Acid–base reactions in sodium chloride media .....	17
7.3.1 Carbonic acid .....	17
7.3.2 2-amino-2-hydroxymethyl-1,3-propanediol (“TRIS”) .....	17
7.3.3 Water .....	17
8. Bibliography .....	18



## 1. Values for various fundamental constants

$$R = 8.314472(15) \text{ J K}^{-1} \text{ mol}^{-1},$$

$$F = 96485.3399(24) \text{ C mol}^{-1},$$

$$0^\circ\text{C} = 273.15 \text{ K (defined)},$$

$$1 \text{ atm} = 101325 \text{ Pa (defined)}$$

(from <http://physics.nist.gov/cuu/Constants/index.html>). For each constant, the standard uncertainty in the least significant digits is given in parentheses.

## 2. Atomic weights

Atomic weights are quoted here (Table 1) to 5 significant figures unless the dependable accuracy is more limited by either the combined uncertainties of the best published atomic weight determinations, or by the variability of isotopic composition in normal terrestrial occurrences (elements **annotated r**). The last significant figure of each tabulated value is considered reliable to at least  $\pm 1$  except when a larger single-digit uncertainty is inserted in parentheses following the atomic weight. In many cases the “official” values (IUPAC, 2006) have more than five significant figures and the precision is considerably better than  $\pm 1$  at the precision shown here. In a few cases the truncation to five significant figures will mean that the true confidence interval is strongly asymmetric relative to the values shown here. Neither the highest nor the lowest actual atomic weight of any normal sample is thought likely to differ from the tabulated value by more than the assigned uncertainty. However, the tabulated values do not apply either to samples of highly exceptional isotopic composition arising from most geological occurrences (elements **annotated g**) or to those whose isotopic composition has been artificially altered. Such might even be found in commerce without disclosure of that modification (elements **annotated m**). Elements that have no stable isotope are excluded from this table except for Th, Pa, and U which do have a characteristic terrestrial isotope composition.

**Table 1** IUPAC (2006) table of standard atomic weights abridged to five significant figures. Scaled to the relative atomic mass  $A(^{12}\text{C}) = 12$  (includes 2007 revisions).

	Name	Symbol	Atomic weight	Annotations
1	Hydrogen	H	1.0079	g m
2	Helium	He	4.0026	
3	Lithium	Li	6.941(2)	g m r
4	Beryllium	Be	9.0122	
5	Boron	B	10.811(7)	g m r
6	Carbon	C	12.011	g r
7	Nitrogen	N	14.007	
8	Oxygen	O	15.999	
9	Fluorine	F	18.998	
10	Neon	Ne	20.180	m
11	Sodium (Natrium)	Na	22.990	
12	Magnesium	Mg	24.305	

Table 1 Continued.

	Name	Symbol	Atomic weight	Annotations
13	Aluminium	Al	26.982	
14	Silicon	Si	28.086	
15	Phosphorus	P	30.974	
16	Sulfur	S	32.065(5)	g r
17	Chlorine	Cl	35.453(2)	m
18	Argon	Ar	39.948	g r
19	Potassium (Kalium)	K	39.098	g
20	Calcium	Ca	40.078(4)	g
21	Scandium	Sc	44.956	
22	Titanium	Ti	47.867	
23	Vanadium	V	50.942	
24	Chromium	Cr	51.996	
25	Manganese	Mn	54.938	
26	Iron	Fe	55.845(2)	
27	Cobalt	Co	58.933	
28	Nickel	Ni	58.693	
29	Copper	Cu	63.546(3)	r
30	Zinc	Zn	65.38(2)	
31	Gallium	Ga	69.723	
32	Germanium	Ge	72.64	
33	Arsenic	As	74.922	
34	Selenium	Se	78.96(3)	
35	Bromine	Br	79.904	
36	Krypton	Kr	83.798(2)	g m
37	Rubidium	Rb	85.468	
38	Strontium	Sr	87.62	
39	Yttrium	Y	88.906	
40	Zirconium	Zr	91.224(2)	g
41	Niobium	Nb	92.906	
42	Molybdenum	Mo	95.96(2)	g
44	Ruthenium	Ru	101.07(2)	g
45	Rhodium	Rh	102.91	
46	Palladium	Pd	106.42	g
47	Silver	Ag	107.87	
48	Cadmium	Cd	112.41	
49	Indium	In	114.82	
50	Tin	Sn	118.71	
51	Antimony (Stibium)	Sb	121.76	g
52	Tellurium	Te	127.60(3)	g
53	Iodine	I	126.90	
54	Xenon	Xe	131.29	g m
55	Caesium	Cs	132.91	
56	Barium	Ba	137.33	
57	Lanthanum	La	138.91	



**Table 1** Continued.

	Name	Symbol	Atomic weight	Annotations
58	Cerium	Ce	140.12	g
59	Praesodymium	Pr	140.91	
60	Neodymium	Nd	144.24	g
62	Samarium	Sm	150.36(2)	g
63	Europium	Eu	151.96	g
64	Gadolinium	Gd	157.25(3)	g
65	Terbium	Tb	158.93	
66	Dysprosium	Dy	162.50	g
67	Holmium	Ho	164.93	
68	Erbium	Er	167.26	g
69	Thulium	Tm	168.93	
70	Ytterbium	Yb	173.05	
71	Lutetium	Lu	174.97	g
72	Hafnium	Hf	178.49(2)	
73	Tantalum	Ta	180.95	
74	Tungsten (Wolfram)	W	183.84	
75	Rhenium	Re	186.21	
76	Osmium	Os	190.23(3)	g
77	Iridium	Ir	192.22	
78	Platinum	Pt	195.08	
79	Gold	Au	196.97	
80	Mercury	Hg	200.59(2)	
81	Thallium	Tl	204.38	
82	Lead	Pb	207.2	g r
83	Bismuth	Bi	208.98	
90	Thorium*	Th	232.04	g
91	Protoactinium*	Pa	231.04	
92	Uranium*	U	238.03	g m

\* These elements have no stable isotope.

### 3. Vapor pressure of water

#### 3.1 Pure water

The vapor pressure of pure water ( $p_\sigma$ ) over the temperature range 273 to 647 K (*i.e.*, from the triple point to the critical point of water) is represented by the expression (Wagner and Pruß, 2002)

$$\ln\left(\frac{p_\sigma}{p_c}\right) = \frac{T_c}{T} \left( a_1 \mathcal{G} + a_2 \mathcal{G}^{1.5} + a_3 \mathcal{G}^3 + a_4 \mathcal{G}^{3.5} + a_5 \mathcal{G}^4 + a_6 \mathcal{G}^{7.5} \right) \quad (1)$$

where  $\mathcal{G} = (1 - T/T_c)$ ,  $T_c = 647.096$  K and  $p_c = 22.064$  MPa. The coefficients are:

$$\begin{aligned} a_1 &= -7.859\,517\,83, & a_4 &= 22.680\,741\,1, \\ a_2 &= 1.844\,082\,59, & a_5 &= -15.961\,871\,9, \\ a_3 &= -11.786\,649\,7, & a_6 &= 1.801\,225\,02. \end{aligned}$$

At 25°C (298.15 K),  $p_\sigma = 3.1698$  kPa.

### 3.2 Sea water

For sea water, the vapor pressure is related to that of pure water,

$$p_\sigma(\text{s/w}) \approx p_\sigma \exp\left(-0.018\phi \sum_B m_B/m^\circ\right) \quad (2)$$

where

- $p_\sigma$  is the vapor pressure of pure water (1),
- $\sum_B m_B$  is the total molality of dissolved species (3),
- $\phi$  is the osmotic coefficient of sea water (4),
- $m^\circ = 1$  mol kg-H<sub>2</sub>O<sup>-1</sup>.

For sea water (of the composition detailed in section 6.1),

$$\sum_B m_B/m^\circ = \frac{31.998S}{10^3 - 1.005S} \quad (3)$$

and the osmotic coefficient at 25°C is given by (Millero, 1974)

$$\begin{aligned} \phi &= 0.90799 - 0.08992 \left( \frac{\frac{1}{2} \sum_B m_B}{m^\circ} \right) + 0.18458 \left( \frac{\frac{1}{2} \sum_B m_B}{m^\circ} \right)^2 \\ &\quad - 0.07395 \left( \frac{\frac{1}{2} \sum_B m_B}{m^\circ} \right)^3 - 0.00221 \left( \frac{\frac{1}{2} \sum_B m_B}{m^\circ} \right)^4 \end{aligned} \quad (4)$$

for  $I = 0.3 - 0.8$  mol kg-H<sub>2</sub>O<sup>-1</sup> ( $S = 16-40$ ). (Although strictly speaking,  $\phi$  is a function of temperature as well as of  $I$ , the change between 0 and 40°C is typically about 1% and can be ignored here.)

At 25°C and  $S = 35$ ,  $p_\sigma(\text{s/w}) = 3.1106$  kPa.

## 4. Densities of various substances

### 4.1 Air-saturated water

The density of air-saturated water in the temperature range 5 to 40°C—*i.e.*, avoiding the temperature of maximum density—is given by the expression (Jones and Harris, 1992)

$$\begin{aligned} \rho_w / (\text{kg m}^{-3}) &= 999.84847 + 6.337563 \times 10^{-2} (t/^\circ\text{C}) - 8.523829 \times 10^{-3} (t/^\circ\text{C})^2 \\ &\quad + 6.943248 \times 10^{-5} (t/^\circ\text{C})^3 - 3.821216 \times 10^{-7} (t/^\circ\text{C})^4. \end{aligned} \quad (5)$$

At 25°C,  $\rho_w = 997.041$  kg m<sup>-3</sup> = 0.997041 g cm<sup>-3</sup>.

## 4.2 Sea water

The density of sea water in the temperature range 0 to 40°C (IPTS 68<sup>1</sup>) and the salinity range 0 to 42 is given by the expression (Millero and Poisson, 1981)

$$\rho_{\text{SW}}/(\text{kg m}^{-3}) = \rho_{\text{SMOW}}/(\text{kg m}^{-3}) + AS + BS^{1.5} + CS^2 \quad (6)$$

where<sup>2</sup>

$$\begin{aligned} \rho_{\text{SMOW}}/(\text{kg m}^{-3}) = & 999.842594 + 6.793952 \times 10^{-2}(t/^\circ\text{C}) \\ & - 9.095290 \times 10^{-3}(t/^\circ\text{C})^2 + 1.001685 \times 10^{-4}(t/^\circ\text{C})^3 \\ & - 1.120083 \times 10^{-6}(t/^\circ\text{C})^4 + 6.536332 \times 10^{-9}(t/^\circ\text{C})^5, \quad (7) \end{aligned}$$

$$\begin{aligned} A = & 8.24493 \times 10^{-1} - 4.0899 \times 10^{-3}(t/^\circ\text{C}) \\ & + 7.6438 \times 10^{-5}(t/^\circ\text{C})^2 - 8.2467 \times 10^{-7}(t/^\circ\text{C})^3 + 5.3875 \times 10^{-9}(t/^\circ\text{C})^4, \quad (8) \end{aligned}$$

$$B = -5.72466 \times 10^{-3} + 1.0227 \times 10^{-4}(t/^\circ\text{C}) - 1.6546 \times 10^{-6}(t/^\circ\text{C})^2, \quad (9)$$

$$C = 4.8314 \times 10^{-4}, \quad (10)$$

$t$  is on IPTS 68 and  $S$  is the salinity.

At 25°C (IPTS 68) and  $S = 35$ ,  $\rho_{\text{SW}} = 1023.343 \text{ kg m}^{-3}$ .

## 4.3 Sodium chloride solutions

The density of a solution of sodium chloride in water in the temperature range 0 to 50°C (see Footnote 1) and the concentration range 0.1 mol kg-H<sub>2</sub>O<sup>-1</sup> to saturation can be calculated from the expression (Lo Surdo *et al.*, 1982)

$$\begin{aligned} \frac{10^3(\rho(\text{NaCl}) - \rho_{\text{SMOW}})}{\text{g cm}^{-3}} = & \left(\frac{m}{m^\circ}\right) \left[ 45.5655 - 0.2341 \left(\frac{t}{^\circ\text{C}}\right) \right. \\ & \left. + 3.4128 \times 10^{-3} \left(\frac{t}{^\circ\text{C}}\right)^2 - 2.7030 \times 10^{-5} \left(\frac{t}{^\circ\text{C}}\right)^3 + 1.4037 \times 10^{-7} \left(\frac{t}{^\circ\text{C}}\right)^4 \right] \\ & + \left(\frac{m}{m^\circ}\right)^{3/2} \left[ -1.8527 + 5.3956 \times 10^{-2} \left(\frac{t}{^\circ\text{C}}\right) - 6.2635 \times 10^{-4} \left(\frac{t}{^\circ\text{C}}\right)^2 \right] \\ & + \left(\frac{m}{m^\circ}\right)^2 \left[ -1.6368 - 9.5653 \times 10^{-4} \left(\frac{t}{^\circ\text{C}}\right) + 5.2829 \times 10^{-5} \left(\frac{t}{^\circ\text{C}}\right)^2 \right] \\ & + 0.2274 \left(\frac{m}{m^\circ}\right)^{5/2} \quad (11) \end{aligned}$$

<sup>1</sup> The International Practical Temperature Scale of 1968 (IPTS 68) has been superseded by the International Temperature Scale of 1990 (ITS 90). A simple equation can be used to relate the two over the oceanographic temperature range 0 to 40°C (Jones and Harris, 1992):

$$t_{90}/^\circ\text{C} = 0.0002 + 0.99975 t_{68}/^\circ\text{C}.$$

<sup>2</sup> SMOW—Standard Mean Ocean Water (Craig, 1961)—is pure water with a specified isotopic composition and free of dissolved gases.

where  $t$  is the temperature (IPTS 68),  $m$  the molality of the sodium chloride solution, and  $m^\circ = 1 \text{ mol kg-H}_2\text{O}^{-1}$ .  $\rho_{\text{SMOW}}$  is calculated using equation (7)—see Footnote 3.

To convert the concentration of sodium chloride expressed in mol kg-soln<sup>-1</sup>— $C(\text{NaCl})$ —to mol kg-H<sub>2</sub>O<sup>-1</sup>, use the expression

$$\frac{m(\text{NaCl})}{m^\circ} = \frac{10^3 C(\text{NaCl})}{10^3 - 58.443 C(\text{NaCl})}. \quad (12)$$

At 25°C and  $m = 0.725 \text{ mol kg-H}_2\text{O}^{-1}$ ,  $\rho(\text{NaCl}) = 1.02581 \text{ g cm}^{-3}$ .

#### 4.4 A mixture of NaCl and HCl at 25°C

An expression based on Young's rule has been developed for the density of a mixture of NaCl and HCl at a temperature of 25°C<sup>4</sup> (Millero, personal communication):

$$\rho_{\text{mix}}(25^\circ\text{C}) = \frac{\rho_{\text{W}}(25^\circ\text{C})[10^3 + m_{\text{T}}(m(\text{HCl}) + m(\text{NaCl}))]}{10^3 + \varphi_{\text{mix}}(m(\text{HCl}) + m(\text{NaCl}))(\rho_{\text{W}}(25^\circ\text{C}))} \quad (13)$$

where  $\rho_{\text{W}}(25^\circ\text{C}) = 0.99704 \text{ g cm}^{-3}$ ,

$$m_{\text{T}} = \frac{36.46m(\text{HCl}) + 58.44m(\text{NaCl})}{m(\text{HCl}) + m(\text{NaCl})}, \quad (14)$$

$$\varphi_{\text{mix}} = \frac{m(\text{HCl})\varphi_{\text{HCl}} + m(\text{NaCl})\varphi_{\text{NaCl}}}{m(\text{HCl}) + m(\text{NaCl})}, \quad (15)$$

and the apparent molar volumes at 25°C,

$$\varphi_{\text{HCl}} = 17.854 + 1.460\sqrt{m} - 0.307m, \quad (16)$$

$$\varphi_{\text{NaCl}} = 16.613 + 1.811\sqrt{m} + 0.094m \quad (17)$$

where  $m = m(\text{HCl}) + m(\text{NaCl})$ . The concentrations  $m(\text{HCl})$  and  $m(\text{NaCl})$  are in mol kg-H<sub>2</sub>O<sup>-1</sup>.

At  $m(\text{HCl}) = 0.2 \text{ mol kg-H}_2\text{O}^{-1}$  and  $m(\text{NaCl}) = 0.5 \text{ mol kg-H}_2\text{O}^{-1}$ ,  $\rho_{\text{mix}}(25^\circ\text{C}) = 1.02056 \text{ g cm}^{-3}$ .

#### 4.5 Various solids

From data of Weast (1975),

$$\text{Potassium chloride: } \rho(\text{KCl}) = 1.984 \text{ g cm}^{-3} \quad (18)$$

<sup>3</sup> In the original paper of Lo Surdo *et al.* (1982) an alternate formulation based on the work of Kell (1975) was used for the density of pure water. The difference is  $< 10^{-5}$  over the temperature range 0–50°C.

<sup>4</sup> At temperatures other than 25°C, equation (13) is not reliable.

$$\text{Sodium chloride: } \rho(\text{NaCl}) = 2.165 \text{ g cm}^{-3} \quad (19)$$

$$\text{Sodium carbonate: } \rho(\text{Na}_2\text{CO}_3) = 2.532 \text{ g cm}^{-3} \quad (20)$$

$$\text{Sodium sulfate: } \rho(\text{Na}_2\text{SO}_4) = 2.68 \text{ g cm}^{-3} \quad (21)$$

Sodium tetraborate decahydrate (borax):

$$\rho(\text{Na}_2\text{B}_4\text{O}_7 \cdot 10\text{H}_2\text{O}) = 1.73 \text{ g cm}^{-3} \quad (22)$$

2-amino-2-hydroxymethyl-1,3-propanediol (“TRIS”):

$$\rho(\text{H}_2\text{NC}(\text{CH}_2\text{OH})_3) = 1.35 \text{ g cm}^{-3} \quad (23)$$

$$\text{2-aminopyridine: } \rho(\text{C}_5\text{H}_6\text{N}_2) = 1.24 \text{ g cm}^{-3} \quad (24)$$

## 5. Virial coefficients for carbon dioxide

### 5.1 Pure carbon dioxide gas

The first virial coefficient of  $\text{CO}_2$  is given by the expression (Weiss, 1974)

$$\begin{aligned} \frac{B(\text{CO}_2, T)}{\text{cm}^3 \text{ mol}^{-1}} = & -1636.75 + 12.0408 \left( \frac{T}{\text{K}} \right) - 3.27957 \times 10^{-2} \left( \frac{T}{\text{K}} \right)^2 \\ & + 3.16528 \times 10^{-5} \left( \frac{T}{\text{K}} \right)^3 \end{aligned} \quad (25)$$

where  $265 < T/\text{K} < 320$ .

At  $25^\circ\text{C}$  (298.15 K),  $B(\text{CO}_2, 298.15 \text{ K}) = -123.2 \text{ cm}^3 \text{ mol}^{-1}$ .

### 5.2 Carbon dioxide in air

For a binary mixture (B–C), it is possible to define a cross-virial coefficient:

$$\delta_{\text{B-C}} = B_{\text{BC}} - \frac{1}{2}(B_{\text{BB}} + B_{\text{CC}}) \quad (26)$$

Weiss (1974) used the Lennard–Jones (6–12) potential to calculate values for the cross-virial coefficient  $\delta$  for the binary mixture:  $\text{CO}_2$ –air (see also SOP 24). He found that the temperature dependence of this parameter could be represented by the equation

$$\frac{\delta(\text{CO}_2 - \text{air})}{\text{cm}^3 \text{ mol}^{-1}} = 57.7 - 0.118 \left( \frac{T}{\text{K}} \right) \quad (27)$$

where  $273 < T/\text{K} < 313$ .

At  $25^\circ\text{C}$  (298.15 K),  $\delta(\text{CO}_2\text{--air}) = 22.5 \text{ cm}^3 \text{ mol}^{-1}$ .

## 6. Salinity and the composition of sea water

### 6.1 The major ion composition of sea water

Traditionally the parameter salinity,  $S$ , has been used to give a measure of the total dissolved solids in sea water. Originally this was intended to be an analytical parameter with the units  $\text{g kg}^{-1}$ , but this direct approach was quickly superseded by the practice of estimating salinity from alternative, simpler procedures (*e.g.*, the measurement of chlorinity or conductivity ratio). The concept of a “constant composition of sea water” is then invoked to relate these parameters to salinity (UNESCO, 1966).

Although the idea of “constant composition of sea water” is recognized as being not strictly accurate, it is a useful device in simplifying the study of the various physicochemical properties of sea water. One example of this is the treatment of sea water as a two-component system—water and sea-salt—to represent its thermodynamic properties (*e.g.*, osmotic coefficient or density—see sections 3.2 and 4.2).

Another is the treatment of sea water as a constant ionic medium in which the thermodynamics of various chemical processes involving minor constituents can be studied (*e.g.*, gas solubility or acid–base equilibria).

Analytical results for the other major components of sea water are usually expressed relative to chlorinity (Table 2) and a standard mean chemical composition of sea water (Table 3) can be calculated using the equilibrium constants for the dissociation of water, carbonic and boric acids.

**Table 2** Standard mean analytical composition of sea water with  $S = 35$  and chlorinity = 19.374.

Component	Relative concentration <sup>a</sup>	mol kg-soln <sup>-1</sup>	Reference
Chloride	0.99889	0.54586	calculated from chlorinity
Sulfate	0.1400	0.02824	Morris and Riley (1966)
Bromide	0.003473	0.00084	Morris and Riley (1966)
Fluoride	0.000067	0.00007	Riley (1965)
Sodium	0.55661	0.46906	from charge balance
Magnesium	0.06626	0.05282	Carpenter and Manella (1973)
Calcium	0.02127	0.01028	Riley and Tongudai (1967)
Potassium	0.0206	0.01021	Riley and Tongudai (1967)
Strontium	0.00041	0.00009	Riley and Tongudai (1967)
Boron	0.000232	0.000416	Uppström (1974)
Total alkalinity	–	0.002400	average surface water
pH = 8.1	–	$10^{-8.1}$	average surface water

<sup>a</sup> Expressed relative to the chlorinity (=  $S/1.80655$ ). Thus the total sulfate (molar mass 96.062 g) at a salinity,  $S$ , is given by

$$S_{\text{T}} = \left( \frac{0.1400}{96.062} \right) \times \left( \frac{S}{1.80655} \right) \text{ mol kg-soln}^{-1}.$$

**Table 3** Standard mean chemical composition of sea water ( $S = 35$ ).

Species	mol kg-soln <sup>-1</sup>	g kg-soln <sup>-1</sup>	mol kg-H <sub>2</sub> O <sup>-1</sup>	g kg-H <sub>2</sub> O <sup>-1</sup>
Cl <sup>-</sup>	0.54586	19.3524	0.56576	20.0579
SO <sub>4</sub> <sup>2-</sup>	0.02824	2.7123	0.02927	2.8117
Br <sup>-</sup>	0.00084	0.0673	0.00087	0.0695
F <sup>-</sup>	0.00007	0.0013	0.00007	0.0013
Na <sup>+</sup>	0.46906	10.7837	0.48616	11.1768
Mg <sup>2+</sup>	0.05282	1.2837	0.05475	1.3307
Ca <sup>2+</sup>	0.01028	0.4121	0.01065	0.4268
K <sup>+</sup>	0.01021	0.3991	0.01058	0.4137
Sr <sup>2+</sup>	0.00009	0.0079	0.00009	0.0079
B(OH) <sub>3</sub>	0.00032	0.0198	0.00033	0.0204
B(OH) <sub>4</sub> <sup>-</sup>	0.00010	0.0079	0.00010	0.0079
CO <sub>2</sub> <sup>*</sup>	0.00001	0.0004	0.00001	0.0004
HCO <sub>3</sub> <sup>-</sup>	0.00177	0.1080	0.00183	0.1117
CO <sub>3</sub> <sup>2-</sup>	0.00026	0.0156	0.00027	0.0162
OH <sup>-</sup>	0.00001	0.0002	0.00001	0.0002
sum of column	1.11994	35.1717	1.16075	36.4531
ionic strength	0.69734	—	0.72275	—

## 6.2 A simplified synthetic sea water recipe

A simplified synthetic sea water recipe can be obtained from the recipe in Table 2 as follows: replace bromide, fluoride, and total alkalinity with chloride and replace strontium with calcium. The resultant composition (Table 4) is the basis of the synthetic sea water that has been used to determine a variety of equilibrium constants for use in sea water (*e.g.*, Dickson, 1990; Roy *et al.*, 1993).

**Table 4** Simplified synthetic sea water composition ( $S = 35$ )<sup>a</sup>.

Species	mol kg-soln <sup>-1</sup>	g kg-soln <sup>-1</sup>	mol kg-H <sub>2</sub> O <sup>-1</sup>	g kg-H <sub>2</sub> O <sup>-1</sup>
Cl <sup>-</sup>	0.54922	19.4715	0.56918	20.1791
SO <sub>4</sub> <sup>2-</sup>	0.02824	2.7128	0.02927	2.8117
Na <sup>+</sup>	0.46911	10.7848	0.48616	11.1768
Mg <sup>2+</sup>	0.05283	1.2840	0.05475	1.3307
Ca <sup>2+</sup>	0.01036	0.4152	0.01074	0.4304
K <sup>+</sup>	0.01021	0.3992	0.01058	0.4137
sum of column	1.11997	35.0675	1.16068	36.3424
ionic strength	0.69713	—	0.72248	—

<sup>a</sup> The composition here is very slightly different from that used by Dickson (1990) or Roy *et al.* (1993). This is the result of minor changes in the molar masses used to compute the various concentrations.

## 7. Equilibrium constants

All the equations for the equilibrium constants presented here use concentrations expressed in moles per kilogram of solution. In addition, with the exception of that for bisulfate ion, all acid dissociation constants are expressed in terms of “total” hydrogen ion concentration (see Chapter 2).

### 7.1 Solubility of carbon dioxide in sea water

The equilibrium constant for the process



*i.e.*,

$$K_0 = [\text{CO}_2^*] / f(\text{CO}_2), \quad (29)$$

is given by the expression (Weiss, 1974)

$$\begin{aligned} \ln(K/k^\circ) = & 93.4517 \left( \frac{100}{T/\text{K}} \right) - 60.2409 + 23.3585 \ln \left( \frac{T/\text{K}}{100} \right) \\ & + S \left[ 0.023517 - 0.023656 \left( \frac{T/\text{K}}{100} \right) + 0.0047036 \left( \frac{T/\text{K}}{100} \right)^2 \right]. \quad (30) \end{aligned}$$

The fugacity of CO<sub>2</sub> gas (see Chapter 2) is expressed in atm;  $k^\circ = 1 \text{ mol kg-soln}^{-1}$ .

At  $S = 35$  and  $t = 25^\circ\text{C}$  (298.15 K),  $\ln(K_0/k^\circ) = -3.5617$ .

### 7.2 Acid–base reactions in sea water

#### 7.2.1 Bisulfate ion

The equilibrium constant for the reaction

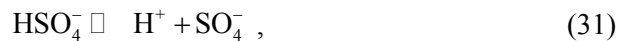

*i.e.*,

$$K_s = [\text{H}^+]_F [\text{SO}_4^{2-}] / [\text{HSO}_4^-], \quad (32)$$

is given by the expression (Dickson, 1990a)

$$\begin{aligned} \ln(K_s/k^\circ) = & \frac{-4276.1}{(T/\text{K})} + 141.328 - 23.093 \ln(T/\text{K}) \\ & + \left( \frac{-13856}{(T/\text{K})} + 324.57 - 47.986 \ln(T/\text{K}) \right) \times \left( \frac{I}{m^\circ} \right)^{1/2} \\ & + \left( \frac{35474}{(T/\text{K})} - 771.54 + 114.723 \ln(T/\text{K}) \right) \times \left( \frac{I}{m^\circ} \right) \\ & - \frac{2698}{(T/\text{K})} \left( \frac{I}{m^\circ} \right)^{3/2} + \frac{1776}{(T/\text{K})} \left( \frac{I}{m^\circ} \right)^2 + \ln(1 - 0.001005S) \quad (33) \end{aligned}$$



where  $k^\circ = 1 \text{ mol kg-soln}^{-1}$  and hydrogen ion concentration is expressed on the “free” scale. The ionic strength is calculated from the expression

$$I/m^\circ = \frac{19.924S}{1000 - 1.005S}. \quad (34)$$

The term  $\ln(1 - 0.001005S)$  converts the value of  $K_S$  from  $\text{mol kg-H}_2\text{O}^{-1}$  (used in Dickson, 1990a) to  $\text{mol kg-soln}^{-1}$ .

At  $S = 35$  and  $t = 25^\circ\text{C}$  (298.15K),  $\ln(K_S/k^\circ) = -2.30$ .

### 7.2.2 Boric acid

The equilibrium constant for the reaction



*i.e.*,

$$K_B = [\text{H}^+][\text{B(OH)}_4^-]/[\text{B(OH)}_3] \quad (36)$$

is given by the expression (Dickson, 1990b)

$$\begin{aligned} \ln\left(\frac{K_B}{k^\circ}\right) = & \frac{-8966.90 - 2890.53S^{1/2} - 77.942S + 1.728S^{3/2} - 0.0996S^2}{(T/\text{K})} \\ & + (148.0248 + 137.1942S^{1/2} + 1.62142S) \\ & + (-24.4344 - 25.085S^{1/2} - 0.2474S)\ln(T/\text{K}) \\ & + 0.053105S^{1/2}(T/\text{K}) \end{aligned} \quad (37)$$

where  $k^\circ = 1 \text{ mol kg-soln}^{-1}$ . This equation is in excellent agreement with the measurements made by Roy *et al.* (1993a); it is also in reasonable agreement with the results of Hansson (1973a).

At  $S = 35$  and  $t = 25^\circ\text{C}$  (298.15 K),  $\ln(K_B/k^\circ) = -19.7964$ .

### 7.2.3 Carbonic acid

The equilibrium constants used here are based on the measurements of Mehrbach *et al.* (1973) and have been converted to the total hydrogen ion pH scale by Lueker *et al.* (2000) who also showed them to be in good agreement with direct measurements of  $p(\text{CO}_2)$ ,  $C_T$ , and  $A_T$ . These constants are in reasonable agreement with those measured by Roy *et al.* (1993b), Goyet and Poisson (1989), and Hansson (1973b).

The equilibrium constant for the reaction

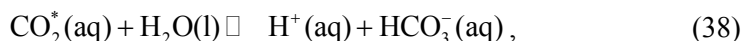

*i.e.*,

$$K_1 = [\text{H}^+][\text{HCO}_3^-]/[\text{CO}_2^*] \quad (39)$$

is given by the expression (Lueker *et al.*, 2000)

$$\log_{10}(K_1/k^\circ) = \frac{-3633.86}{(T/K)} + 61.2172 - 9.67770 \ln(T/K) + 0.011555S - 0.0001152S^2 \quad (40)$$

where  $k^\circ = 1 \text{ mol kg-soln}^{-1}$ .

At  $S = 35$  and  $t = 25^\circ\text{C}$  (298.15 K),  $\log_{10}(K_1/k^\circ) = -5.8472$ .

The equilibrium constant for the reaction

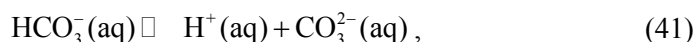

*i.e.*,

$$K_2 = [\text{H}^+][\text{CO}_3^{2-}]/[\text{HCO}_3^-], \quad (42)$$

is given by the expression (Lueker *et al.*, 2000)

$$\log_{10}(K_2/k^\circ) = \frac{-471.78}{(T/K)} - 25.9290 + 3.16967 \ln(T/K) + 0.01781S - 0.0001122S^2 \quad (43)$$

where  $k^\circ = 1 \text{ mol kg-soln}^{-1}$ .

At  $S = 35$  and  $t = 25^\circ\text{C}$  (298.15 K),  $\log_{10}(K_2/k^\circ) = -8.9660$ .

#### 7.2.4 Hydrogen fluoride

The equilibrium constant for the reaction

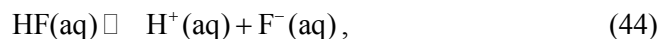

*i.e.*,

$$K_F = [\text{H}^+][\text{F}^-]/[\text{HF}], \quad (45)$$

is given by the expression (Perez and Fraga, 1987)

$$\ln(K_F/k^\circ) = \frac{874}{(T/K)} - 9.68 + 0.111S^{1/2} \quad (46)$$

where  $k^\circ = 1 \text{ mol kg-soln}^{-1}$ . This equation gives values that are in reasonable agreement with those suggested by Dickson and Riley (1979a).

At  $S = 35$  and  $t = 25^\circ\text{C}$  (298.15K),  $\ln(K_F/k^\circ) = -6.09$ .

#### 7.2.5 Phosphoric acid

The expressions below are from Millero (1995)<sup>5</sup> and are a composite of measurements by Kester and Pytkowicz (1967), Dickson and Riley (1979b), and

<sup>5</sup> 0.015 has been subtracted from the constant term in each of these expressions: (49), (52), (55) to convert—approximately—from the SWS pH scale (including HF) used by Millero (1995) to the “total” hydrogen ion scale used here.

Johansson and Wedborg (1979).

The equilibrium constant for the reaction



*i.e.*,

$$K_{1\text{P}} = [\text{H}^+][\text{H}_2\text{PO}_4^-]/[\text{H}_3\text{PO}_4], \quad (48)$$

is given by the expression

$$\begin{aligned} \ln(K_{1\text{P}}/k^\circ) = & \frac{-4576.752}{T/\text{K}} + 115.525 - 18.453 \ln(T/\text{K}) \\ & + \left( \frac{-106.736}{(T/\text{K})} + 0.69171 \right) S^{1/2} + \left( -\frac{0.65643}{(T/\text{K})} - 0.01844 \right) S \end{aligned} \quad (49)$$

where  $k^\circ = 1 \text{ mol kg-soln}^{-1}$ .

At  $S = 35$  and  $t = 25^\circ\text{C}$  (298.15 K),  $\ln(K_{1\text{P}}/k^\circ) = -3.71$ .

The equilibrium constant for the reaction

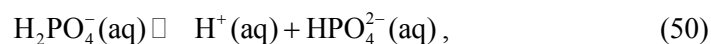

*i.e.*,

$$K_{2\text{P}} = [\text{H}^+][\text{HPO}_4^{2-}]/[\text{H}_2\text{PO}_4^-], \quad (51)$$

is given by the expression

$$\begin{aligned} \ln(K_{2\text{P}}/k^\circ) = & \frac{-8814.715}{T/\text{K}} + 172.0883 - 27.927 \ln(T/\text{K}) \\ & + \left( \frac{-160.340}{(T/\text{K})} + 1.35666 \right) S^{1/2} + \left( \frac{0.37335}{(T/\text{K})} - 0.05778 \right) S \end{aligned} \quad (52)$$

where  $k^\circ = 1 \text{ mol kg-soln}^{-1}$ .

At  $S = 35$  and  $t = 25^\circ\text{C}$  (298.15 K),  $\ln(K_{2\text{P}}/k^\circ) = -13.727$ .

The equilibrium constant for the reaction

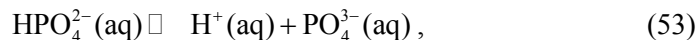

*i.e.*,

$$K_{3\text{P}} = [\text{H}^+][\text{PO}_4^{3-}]/[\text{HPO}_4^{2-}], \quad (54)$$

is given by the expression

$$\begin{aligned} \ln(K_{3\text{P}}/k^\circ) = & \frac{-3070.75}{(T/\text{K})} - 18.141 + \left( \frac{17.27039}{(T/\text{K})} + 2.81197 \right) S^{1/2} \\ & + \left( \frac{-44.99486}{(T/\text{K})} - 0.09984 \right) S \end{aligned} \quad (55)$$

where  $k^\circ = 1 \text{ mol kg-soln}^{-1}$ .

At  $S = 35$  and  $t = 25^\circ\text{C}$  (298.15 K),  $\ln(K_{3P}/k^\circ) = -20.24$ .

### 7.2.6 Silicic acid

The equilibrium constant for the reaction

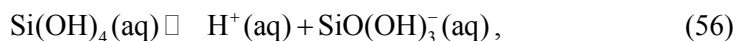

*i.e.*,

$$K_{\text{Si}} = [\text{H}^+][\text{SiO}(\text{OH})_3^-]/[\text{Si}(\text{OH})_4], \quad (57)$$

is given by the expression (Millero, 1995)

$$\begin{aligned} \ln(K_{\text{Si}}/k^\circ) = & \frac{-8904.2}{(T/\text{K})} + 117.385 - 19.334 \ln(T/\text{K}) \\ & + \left( \frac{-458.79}{(T/\text{K})} + 3.5913 \right) (I/m^\circ)^{1/2} + \left( \frac{188.74}{(T/\text{K})} - 1.5998 \right) (I/m^\circ) \\ & + \left( \frac{-12.1652}{(T/\text{K})} + 0.07871 \right) (I/m^\circ)^2 + \ln(1 - 0.001005S) \end{aligned} \quad (58)$$

where  $k^\circ = 1 \text{ mol kg-soln}^{-1}$ . This expression is based on the results of Sjöberg *et al.* (1981) and the review by Baes and Mesmer (1976); 0.015 has been subtracted from the constant (see Footnote 5).

The ionic strength is calculated from the expression

$$I/m^\circ = \frac{19.924S}{1000 - 1.005S} \approx 0.02S. \quad (59)$$

The term  $\ln(1 - 0.001005S)$  converts the value of  $K_{\text{Si}}$  from  $\text{mol kg-H}_2\text{O}^{-1}$  to  $\text{mol kg-soln}^{-1}$ ;  $m^\circ$  is as in equation (11).

At  $S = 35$  and  $t = 25^\circ\text{C}$  (298.15 K),  $\ln(K_{\text{Si}}/k^\circ) = -21.61$ .

### 7.2.7 Water

The equilibrium constant for the reaction

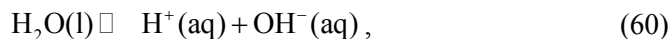

*i.e.*,

$$K_{\text{w}} = [\text{H}^+][\text{OH}^-], \quad (61)$$

is given by the expression (Millero, 1995)

$$\begin{aligned} \ln(K_{\text{w}}/(k^\circ)^2) = & \frac{-13847.26}{(T/\text{K})} + 148.9652 - 23.6521 \ln(T/\text{K}) \\ & + \left( \frac{118.67}{(T/\text{K})} - 5.977 + 1.0495 \ln(T/\text{K}) \right) S^{1/2} - 0.01615S \end{aligned} \quad (62)$$

where  $k^\circ = 1 \text{ mol kg-soln}^{-1}$ . This expression is based on results published by Hansson (1973a), Culberson and Pytkowicz (1973), and Dickson and Riley

(1979a). Note that 0.015 has been subtracted from the constant term (see Footnote 5).

At  $S = 35$  and  $t = 25^\circ\text{C}$  (298.15 K),  $\ln(K_W/(k^\circ)^2) = -30.434$ .

### 7.3 Acid–base reactions in sodium chloride media

The values given here are appropriate to a background medium with  $C(\text{NaCl}) = 0.7 \text{ mol kg-soln}^{-1}$  and at a temperature of  $25^\circ\text{C}$ .

#### 7.3.1 Carbonic acid

The values given here are from Dyrssen and Hansson (1973).

The equilibrium constant for the reaction

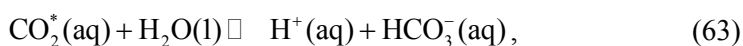

*i.e.*,

$$K_1 = [\text{H}^+][\text{HCO}_3^-]/[\text{CO}_2^*], \quad (64)$$

at  $C(\text{NaCl}) = 0.7 \text{ mol kg-soln}^{-1}$  and  $t = 25^\circ\text{C}$  is

$$\ln(K_1/k^\circ) = -13.82. \quad (65)$$

The equilibrium constant for the reaction

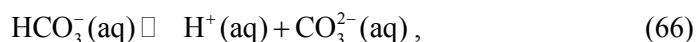

*i.e.*,

$$K_2 = [\text{H}^+][\text{CO}_3^{2-}]/[\text{HCO}_3^-], \quad (67)$$

at  $C(\text{NaCl}) = 0.7 \text{ mol kg-soln}^{-1}$  and  $t = 25^\circ\text{C}$  is

$$\ln(K_2/k^\circ) = -21.97. \quad (68)$$

#### 7.3.2 2-amino-2-hydroxymethyl-1,3-propanediol (“TRIS”)

The equilibrium constant for the reaction

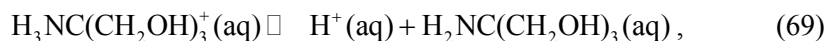

*i.e.*,

$$K_{\text{tris}} = [\text{H}^+][\text{H}_2\text{NC}(\text{CH}_2\text{OH})_3]/[\text{H}_3\text{NC}(\text{CH}_2\text{OH})_3^+], \quad (70)$$

at  $C(\text{NaCl}) = 0.7 \text{ mol kg-soln}^{-1}$  and  $t = 25^\circ\text{C}$  is

$$\ln(K_{\text{TRIS}}/k^\circ) = -18.90 \quad (71)$$

(Millero *et al.*, 1987).

#### 7.3.3 Water

The equilibrium constant for the reaction

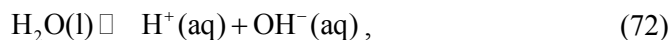

*i.e.*,

$$K_w = [\text{H}^+][\text{OH}^-], \quad (73)$$

at  $C(\text{NaCl}) = 0.7 \text{ mol kg-soln}^{-1}$  and  $t = 25^\circ\text{C}$  is

$$\ln(K_w/(k^\circ)^2) = -31.71 \quad (74)$$

(Dyrssen and Hansson, 1973).

## 8. Bibliography

- Baes, Jr., C.F. and Mesmer, R.E. 1976. *The Hydrolysis of Cations*. John Wiley & Sons, Inc., 489 pp.
- Carpenter, J.H. and Manella, M.E. 1973. Magnesium to chlorinity ratios in sea water. *J. Geophys. Res.* **78**: 3621–3626.
- Craig, H. 1961. Standards for reporting concentrations of deuterium and oxygen-18 in natural waters. *Science* **133**: 1833–1834.
- Culberson, C.H. and Pytkowicz, R.M. 1973. Ionization of water in seawater. *Mar. Chem.* **1**: 309–316.
- Dickson, A.G. and Riley, J.P. 1979a. The estimation of acid dissociation constants in seawater media from potentiometric titrations with strong base. I. The ionic product of water ( $K_w$ ). *Mar. Chem.* **7**: 89–99.
- Dickson, A.G. and Riley, J.P. 1979b. The estimation of acid dissociation constants in seawater media from potentiometric titrations with strong base. II. The dissociation of phosphoric acid. *Mar. Chem.* **7**: 101–109.
- Dickson, A.G. 1990a. Standard potential of the reaction:  $\text{AgCl}(\text{s}) + \frac{1}{2}\text{H}_2(\text{g}) = \text{Ag}(\text{s}) + \text{HCl}(\text{aq})$ , and the standard acidity constant of the ion  $\text{HSO}_4^-$  in synthetic sea water from 273.15 to 318.15 K. *J. Chem. Thermodyn.* **22**: 113–127.
- Dickson, A.G. 1990b. Thermodynamics of the dissociation of boric acid in synthetic sea water from 273.15 to 298.15 K. *Deep-Sea Res.* **37**: 755–766.
- Dyrssen, D. and Hansson, I. 1973. Ionic medium effects in sea water — a comparison of acidity constants of carbonic acid and boric acid in sodium chloride and synthetic sea water. *Mar. Chem.* **1**: 137–149.
- Goyet C. and Poisson, A. 1989. New determination of carbonic acid dissociation constants in seawater as a function of temperature and salinity. *Deep-Sea Res.* **36**: 1635–1654.
- Hansson, I. 1973a. Determination of the acidity constant of boric acid in synthetic sea water media. *Acta Chem. Scandinavica* **27**: 924–930.
- Hansson, I. 1973b. The determination of the dissociation constants of carbonic acid in synthetic sea water in the salinity range of 20–40‰ and temperature range of 5–3°C. *Acta Chem. Scandinavica* **27**: 931–944.
- IUPAC 1993. 1991 Table of atomic weights abridged to five significant figures. *Chem. Internat.* **15**: 128–129. (Based upon the 1991 table published in *Pure and Applied Chemistry* 1992, **64**: 1519–1534.)
- IUPAC 2006. Atomic weights of the elements 2005. *Pure Appl. Chem.* **78**: 2051–2066. (revised 2007 see: [http://www.iupac.org/news/archives/2007/atomic-weights\\_revised07.html](http://www.iupac.org/news/archives/2007/atomic-weights_revised07.html))
- Jones, F.E. and Harris, G.L. 1992. ITS-90 density of water formulation for volumetric standards calibration. *J. Res. Nat. Inst. Stand. Technol.* **97**: 335–340.
- Kell, G.S. 1975. Density, thermal expansivity, and compressibility of water from 0 to 150 °C: correlations and tables for atmospheric pressure and saturation reviewed and expressed on 1968 temperature scale. *J. Chem. Eng. Data* **20**: 97–105.

- Kester, D.R. and Pytkowicz, R.M. 1967. Determination of the apparent dissociation constants of phosphoric acid in sea water. *Limnol. Oceanogr.* **12**: 243–252.
- Khoo, K.H., Ramette, R.W., Culberson, C.H. and Bates, R.G. 1977. Determination of hydrogen ion concentrations in seawater from 5 to 40 °C: standard potentials at salinities from 20 to 45‰. *Anal. Chem.* **49**: 29–34.
- Lo Surdo, A., Alzola, E.M. and Millero, F.J. 1982. The ( $p, V, T$ ) properties of concentrated aqueous electrolytes. I. Densities and apparent molar volumes of NaCl, Na<sub>2</sub>SO<sub>4</sub>, MgCl<sub>2</sub>, and MgSO<sub>4</sub> solutions from 0.1 mol·kg<sup>-1</sup> to saturation and from 273.15 to 323.15 K. *J. Chem. Thermodyn.* **14**: 649–662.
- Lueker, T.J., Dickson, A.G. and Keeling, C.D. 2000. Ocean pCO<sub>2</sub> calculated from dissolved inorganic carbon, alkalinity, and equations for  $K_1$  and  $K_2$ : validation based on laboratory measurements of CO<sub>2</sub> in gas and seawater at equilibrium. *Mar. Chem.* **70**: 105–119.
- Mehrbach, C., Culberson, C.H., Hawley, J.E. and Pytkowicz, R.M. 1973. Measurement of the apparent dissociation constants of carbonic acid in seawater at atmospheric pressure. *Limnol. Oceanogr.* **18**: 897–907.
- Millero, F.J. 1974. Seawater as a multicomponent electrolyte solution. pp. 3–80. *In: The Sea, Vol. 5, Edited by E.D. Goldberg.*
- Millero, F.J. 1995. Thermodynamics of the carbon dioxide system in the oceans. *Geochim. Cosmochim. Acta* **59**: 661–677.
- Millero, F.J. and Poisson, A. 1981. International one-atmosphere equation of state for sea water. *Deep-Sea Res.* **28**: 625–629.
- Millero, F.J., Hershey, J.P. and Fernandez, M. 1987. The  $pK^*$  of TRISH<sup>+</sup> in Na-K-Mg-Ca-Cl-SO<sub>4</sub> Brines – pH scales. *Geochim. Cosmochim. Acta* **51**: 707–711.
- Morris, A.W. and Riley, J.P. 1966. The bromide/chlorinity and sulphate/chlorinity ratio in sea water. *Deep-Sea Res.* **13**: 699–705.
- Perez, F.F. and Fraga, F. 1987. Association constant of fluoride and hydrogen ions in seawater. *Mar. Chem.* **21**: 161–168.
- Riley, J.P. 1965. The occurrence of anomalously high fluoride concentrations in the North Atlantic. *Deep-Sea Res.* **12**: 219–220.
- Riley, J.P. and Tongudai, M. 1967. The major cation / chlorinity ratios in sea water. *Chem. Geol.* **2**: 263–269.
- Roy, R.N., Roy, L.N., Lawson, M., Vogel, K.M., Porter-Moore, C., Davis, W. and Millero, F.J. 1993a. Thermodynamics of the dissociation of boric acid in seawater at  $S = 35$  from 0 to 55 °C. *Mar. Chem.* **44**: 243–248.
- Roy, R.N., Roy, L.N., Vogel, K.M., Porter-Moore, C., Pearson, T., Good, C.E., Millero, F.J. and Cambell, D.J. 1993b. Determination of the ionization constants of carbonic acid in seawater in salinities 5 to 45 and temperatures 0 to 45 °C. *Mar. Chem.* **44**: 249–267.
- Sjöberg, S., Nordin, A. and Ingri, N. 1981. Equilibrium and structural studies of silicon(IV) and aluminium(III) in aqueous solution. II. Formation constants for the monosilicate ions SiO(OH)<sub>3</sub><sup>-</sup> and SiO<sub>2</sub>(OH)<sub>2</sub><sup>2-</sup>. A precision study at 25 °C in a simplified seawater medium. *Mar. Chem.* **10**: 521–532.
- UNESCO 1966. Second report of the Joint Panel on Oceanographic Tables and Standards. UNESCO Tech. Papers Mar. Sci. No. 4.
- Uppström, L.R. 1974. Boron/chlorinity ratio of deep-sea water from the Pacific Ocean. *Deep-Sea Res.* **21**: 161–162.
- Wagner, W. and Pruß, A. 2002. The IAPWS formulation 1995 for the thermodynamic properties of ordinary water substance for general and scientific use. *J. Phys. Chem. Ref. Data* **31**: 387–535.
- Weast, R.F. 1975. CRC Handbook of Chemistry and Physics, 56th edition, Chemical Rubber Company.
- Weiss, R.F. 1974. Carbon dioxide in water and seawater: the solubility of a non-ideal gas. *Mar. Chem.* **2**: 203–215.

**Errata - to Guide to best practices for ocean CO<sub>2</sub> measurements. 2007. PICES Special Publication. Dickson, A. G., Sabine, C. L. and Christian, J. R. (Eds.)**

**1. Chapter 5; Page 5, Section 3.1:**

**“4” in the 2nd to last term of equation (1) should be a superscript  
The word “polynomial” should be “expression”**

**2. SOP 3b; Page 8, equation (13):**

$$A_T + \left( \frac{S_T}{1 + K_S Z / (f [H'])} \right) + \left( \frac{F_T}{1 + K_F Z / (f [H'])} \right) + \left( \frac{m_0 + m}{m_0} \right) \left( \frac{f [H']}{Z} \right) - \left( \frac{m}{m_0} \right) C = 0$$

**should be**

$$A_T + \left( \frac{S_T}{1 + K_S Z / (f [H'])} \right) + \left( \frac{F_T}{1 + K_F / (f [H'])} \right) + \left( \frac{m_0 + m}{m_0} \right) \left( \frac{f [H']}{Z} \right) - \left( \frac{m}{m_0} \right) C = 0$$

**3. SOP 5; Page 8, equation (9):  $f(\text{CO}_2)_{T_S, \text{wet}} = f(\text{CO}_2)_{T_S, \text{wet}} \cdot \exp[0.0423(T_S - T_E)]$**

**should be  $f(\text{CO}_2)_{T_S, \text{wet}} = f(\text{CO}_2)_{T_E, \text{wet}} \cdot \exp[0.0423(T_S - T_E)]$**

**4. SOP 7; Page 4:** Unnecessary extra trailing zeros were deleted from tabulated values of maximum standard deviation and CV.

**5. SOP 6b; typo in equation 7, it should be:**

$$\text{pH} = \text{p}K_2 + \log_{10} \left( \frac{A_1 / A_2 - \varepsilon_1(\text{HI}^-) / \varepsilon_2(\text{HI}^-)}{\varepsilon_1(\text{I}^{2-}) / \varepsilon_2(\text{HI}^-) - (A_1 / A_2) \varepsilon_2(\text{I}^{2-}) / \varepsilon_2(\text{HI}^-)} \right)$$